



CorePro LED PLC 4P

CorePro LED PLC 6.5W 840 4P G24q-2

The CorePro LED PLC 4P integrates a LED light source into a traditional fluorescent form factor. This product is the ideal solution for uplamping in general lighting applications: it meets basic lighting requirements, offers significant energy savings, and is environmentally friendly.

Product data

General Information		Temperature	
Cap-Base	G24Q-2 [G24q-2]	Warm Up Time to 60% Light (Nom)	0.5 s
EU RoHS compliant	Yes	Power Factor (Nom)	0.9
Nominal Lifetime (Nom)	30000 h	Voltage (Nom)	20-50 V
Switching Cycle	50000X		
Light Technical			
Color Code	840 [CCT of 4000K]	T-Ambient (Max)	35 °C
Beam Angle (Nom)	120 °	T-Ambient (Min)	-20 °C
Luminous Flux (Nom)	700 lm	T-Storage (Max)	65 °C
Color Designation	Cool White (CW)	T-Storage (Min)	-40 °C
Correlated Color Temperature (Nom)	4000 K	T-Case Maximum (Nom)	66 °C
Luminous Efficacy (rated) (Nom)	92.31 lm/W	Controls and Dimming	
Color Consistency	<6	Dimmable	No
Color Rendering Index (Nom)	83	Mechanical and Housing	
LLMF At End Of Nominal Lifetime (Nom)	70 %	Product Length	100 mm
Operating and Electrical		Approval and Application	
Input Frequency	30000-80000 Hz	Energy Efficiency Label (EEL)	A+
Power (Nom)	6.5 W	Energy Saving Product	Yes
Lamp Current (Max)	300 mA	Approval Marks	TUV CE marking RoHS compliance KEMA Keur certificate
Lamp Current (Min)	150 mA		
Starting Time (Nom)	0.5 s		

CorePro LED PLC 4P

Energy Consumption kWh/1000 h	9 kWh
Product Data	
Full product code	871869654121000
Order product name	CorePro LED PLC 6.5W 840 4P G24q-2
EAN/UPC - Product	8718696541210
Order code	929001201102

Numerator - Quantity Per Pack	1
Numerator - Packs per outer box	10
Material Nr. (12NC)	929001201102
Net Weight (Piece)	0.078 kg

Dimensional drawing

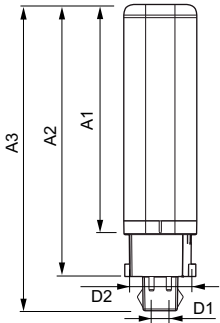

LEDtube PLC 6.5W G24q-2/840 4P

Product	D1	D2	A1	A2	A3
CorePro LED PLC 6.5W 840 4P G24q-2	24.3 mm	28.4 mm	105.8 mm	125 mm	140.6 mm

Photometric data

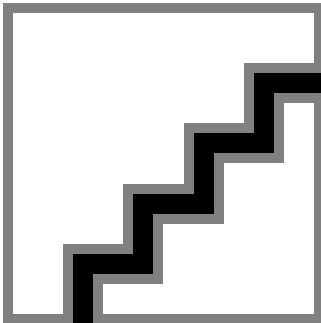

LEDtube PLC 100mm 7W G24Q-2 840 700lm

LEDtube PLC 100mm 9W G24Q-3 840 1000lm

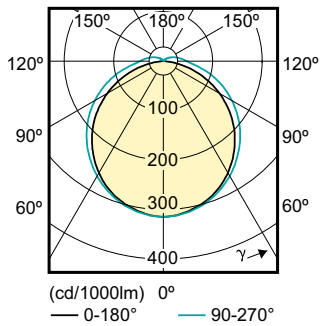

CorePro LED PLC 4P

Lifetime

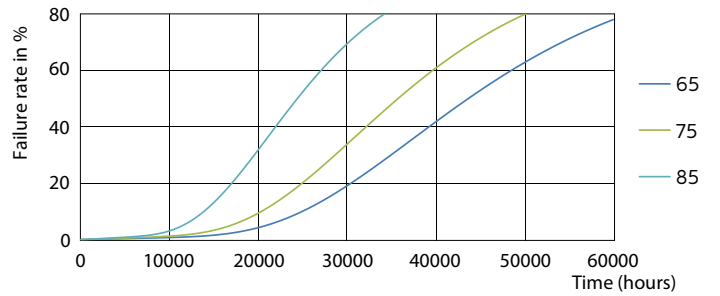
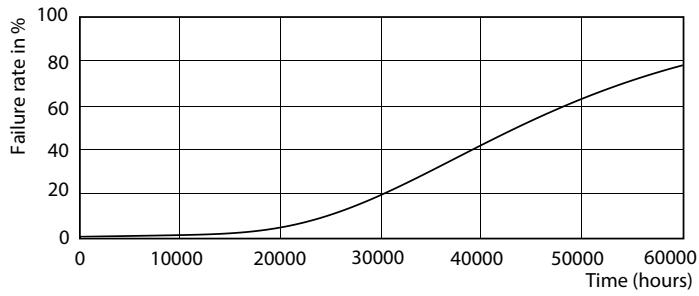

LEDtube PLC 100mm 7W G24Q-2 830 650lm

LEDtube PLC 100mm 7W G24Q-2 830 650lm

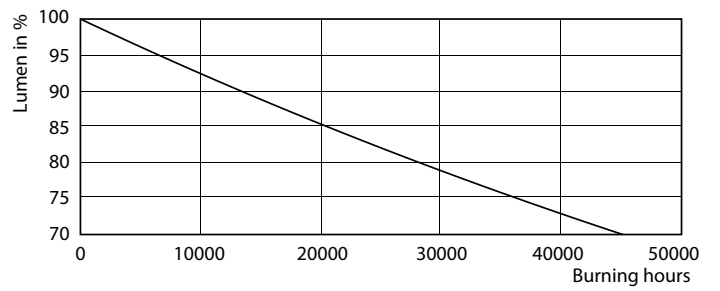
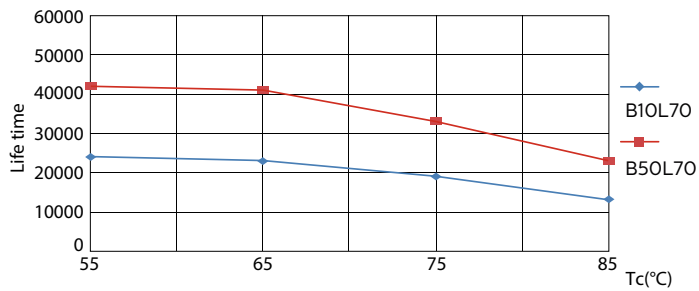

LEDtube PLC 100mm 7W G24Q-2 830 650lm

LEDtube PLC 100mm 7W G24Q-2 830 650lm

LEDtube PLC 100mm 7W G24Q-2 830 650lm

