

Universal dimmer insert, 2-gang

Operating instructions

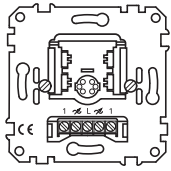

Art.- no. MTN568099

For your safety



DANGER

Risk of fatal injury from electrical current.

All work on the device should only be carried out by trained and skilled electricians. The country-specific regulations must be followed.



DANGER

Risk of fatal injury from electrical current.

The outputs may carry an electrical voltage even when the dimmer is switched off. Always disconnect the fuse in the incoming circuit from the supply before working on connected loads.

Universal dimmer insert introduction

You can use the universal dimmer insert (referred to below as **dimmer**) for switching and dimming ohmic, capacitive or inductive loads on 2 channels via a push-button module and the corresponding rockers.

The dimmer automatically recognises the connected load after the corresponding key has been actuated per channel. The built-in memory function can store the brightness level per channel that was last set (can be switched off).

The dimmer is overload-proof, short-circuit-proof and hum-free, and has a soft start function which softly dims up a connected load.



CAUTION

Danger of device malfunctions.

The dimmer requires a minimum load of 50 VA per channel. If this is not met, malfunctions may arise.



In case of overloading or short circuiting, the dimmer will switch the affected channel off. After rectifying the problem, perform the load detection again on the affected channel (see the "Putting the dimmer into operation" section).



CAUTION

Damage to connected devices.

Connected devices can be damaged if you connect mixed loads (inductive and capacitive) at the same time.



CAUTION

The device could become damaged.

Only dimmable transformers are allowed to be connected to the dimmer.



Do not use dimmers on socket-outlets! The risk of operating unsuitable devices is too high.

The dimmer has an extension input for each channel (A).

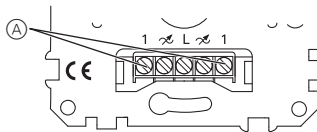

You can connect the following extension units:

- up to ten extension TELE inserts (art. no. MTN573998)
- any number of mechanical extension units (conventional push-buttons)



The extension unit cable should not exceed 10 m in length.



If the load on connected wound transformers is too low, the dimmer may malfunction during operation. The load on the transformer should therefore be at least 60 % of the nominal power of the transformer.



If you do not install the dimmer in a single, standard flush mounting box, the maximum permissible load is reduced as follows, due to the restricted heat dissipation:

Load reduction by	Dimmer installed in cavity or wooden walls*	Several dimmers installed in combination *	Dimmer in 1-gang surface-mounted housing
10 %			X
15 %	X		
20 %		X	

* If several factors apply at once, add the load reductions together.

Completing the dimmer

Complete the dimmer with:

- 2-gang push-button module (art. no. MTN568499), rockers for 2-gang push-button module (art. nos. MTN6192.., MTN6252..) and frame.
- 2-gang push-button module (art. no. MTN568199), rockers for 2-gang push-button module (art. no. MTN6262..) and frame.

Installing the dimmer



DANGER

Risk of fatal injury from electrical current.

The outputs may carry an electrical voltage even when the dimmer is switched off. Always disconnect the fuse in the incoming circuit from the supply before working on connected loads.

Wiring the dimmer



Always wire the right channel (A) first. The left channel (B) of the dimmer only functions when a load is connected on the right channel.

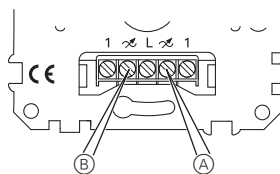

- 1 Wire up the dimmer according to the application.

Applications:

- Dimmer as stand-alone device (only right channel connected):

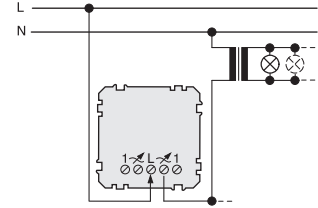

- Dimmer as stand-alone device (right and left channels connected):

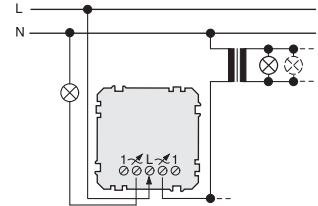

- Dimmer with extension unit: Connection example with a push-button (B) and an extension TELE insert (C).

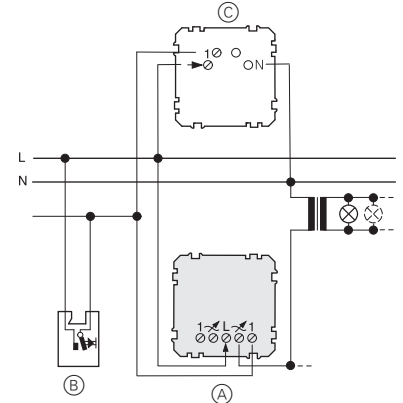

Installing the dimmer

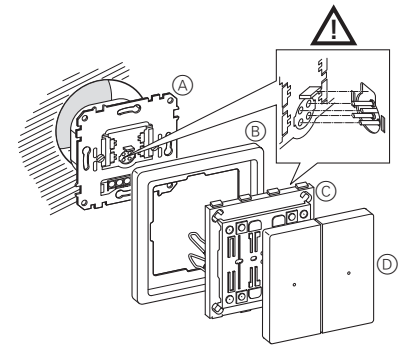

- 1 Install the dimmer (A) in the flush-mounted socket.
- 2 Press the rockers (D) onto the push-button module (C).



CAUTION

Bending the contact pins.

The plug prongs on the rear of the push-button module can become bent if tilted excessively. Therefore always plug the push-button module in as straight as possible.

- 3 Plug the push-button module (C) with its frame (B) onto the dimmer (A).

Putting the dimmer into operation

After installation:

- ① switch on the mains voltage.
- ② For each channel, press the corresponding key to perform load detection.

The corresponding channel will be switched on and off several times (flickers) for approx. 10 seconds. The dimmer then briefly switches off and dims to maximum brightness.

The dimmer has detected the load and is ready for operation.



After each interruption of the mains voltage, a load detection must be carried out.

Operating the dimmer

Operate the dimmer via one of the following:

- Rockers on the dimmer itself
- Sensor cover on an electrical extension unit
- Mechanical extension unit (conventional push-button)

Switching/dimming connected luminaires



- Ⓐ Switching on/off: press the button briefly
- Ⓑ Dimming brighter/darker: press the button and hold it down

Switching memory function for each channel on and off

- ① Actuate the respective rocker at least ten times quickly in a row to switch the memory function on or off.

What should I do if there is a problem?

The dimmer regularly dims down or switches off during operation.

Allow the dimmer to cool down and reduce the connected load.

The dimmer cannot be switched back on.

- Allow the dimmer to cool down further and reduce the connected load.
- If there is a possible short circuit, have an electrician rectify it. The dimmer must now recognise the load again. If necessary, switch the dimmer on once for load detection (see "Putting the dimmer into operation").

Both channels cannot be operated any more.

Check light on the right channel.

The left channel cannot be operated any more.

Check light on the left channel.

Technical data

Mains voltage:	AC 220–230 V, 50/60 Hz
Nominal power/ per channel:	at 50 Hz: 50–200 VA at 60 Hz: 50–170 VA
Neutral conductor:	not required
Features:	overload-proof, hum-free, soft start, load detection, memory function (can be switched off).

Schneider Electric Industries SAS

If you have technical questions, please contact the Customer Care Center in your country.

www.schneider-electric.com

This product must be installed, connected and used in compliance with prevailing standards and/or installation regulations. As standards, specifications and designs develop from time to time, always ask for confirmation of the information given in this publication.