

## Ceiling-recessed luminaire

IP44 LED Downlight with white adjustable trim and with 38° beam angle for indoor applications. Total luminous flux: 900 lm. Luminaire input power: 9 W. Luminaire efficacy: 100 lm/W. Correlated colour temperature\*: 3000 Kelvin. Lifetime: 50.000hrs @L80. Colour Rendering Index: CRI > 90 for best light quality. Chromaticity tolerance (initial MacAdam): 3. Included connectors for easy and tool-free loop-in loop-out wiring, LED driver suitable for use with leading and trailing edge dimmers from approved manufacturers. Compatible with Plug&Play Emergency kit for 3 hour emergency conversion (96634428 or 96635766). Covering with insulation materials possible. Lumen package adjustable on site 2 steps: (FLEX1 900 lm (9W), FLEX2 - 600 lm (6W)). Detailed power setting information available on [www.THORNeco.com](http://www.THORNeco.com). Dimensions: Ø82 x 59 mm, weight: 0.32 kg.

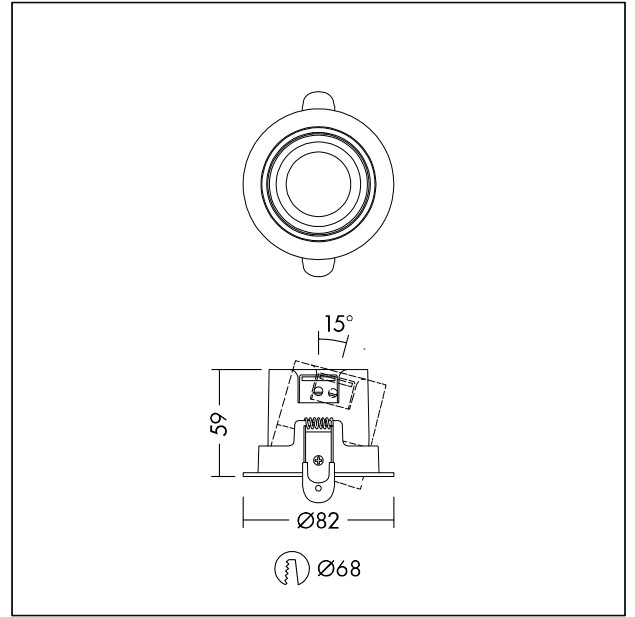

TE\_LILY\_F\_tilted\_trim\_persp.jpg



TE\_LILY\_M\_SPOT\_STD.wmf

## Light Distribution

## STD - standard

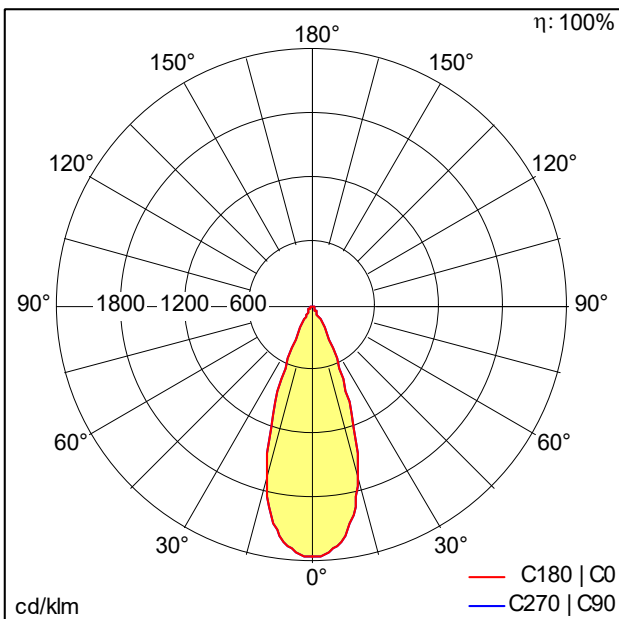

TE\_LILY\_LED\_SPOT\_IP44\_38\_68\_850\_930\_ADJ\_WH.idt

- Light Source: LED
- Luminaire luminous flux\*: 900 lm
- Total emergency luminous flux: 300 lm
- Luminaire efficacy\*: 100 lm/W
- Colour Rendering Index min.: 90
- Correlated colour temperature\*: 3000 Kelvin
- Chromaticity tolerance (initial MacAdam): 3
- Rated median useful life\*:  
L80 50000 h at 25 °C
- Ballast: 1x LED\_Con
- Luminaire input power\*: 9 W Power factor = 0.9
- Dimming: PCDCG dimmable to 10%
- Maintenance category CIE 97: D - Enclosed IP2X
- Total harmonic distortion (THD): 20.00 %

This product contains a light source of energy efficiency class E.

All values marked with an \* are rated values. Connected electrical load and luminous flux are subject to an initial tolerance of +/- 10%, the most similar colour temperature is subject to an initial tolerance of +/- 150K. Unless stated otherwise, the values apply to an ambient temperature of 25°C.