



Downlight Performer HG

- Geavanceerde, hoogwaardige LED-downlight
- Uniek optisch lensconcept met hoogglans (HG) reflector en lage verblinding
- Minimale armatuur-hoogte (max 73mm)
- Directe vervanging voor CFL downlights
- IP44 (lichtuitvoerkant)
- Voorzien van beschermingsfolie ter voorkoming van stof en vuil in het armatuur gedurende de montage



Specificaties

Artikelcode	Artikelomschrijving	Equivalent (W)	Vermogen (W)	Lumen	Efficiëntie (lm/W)	UGR	CCT (K)	CRI	Gewicht (kg/st)
DALI2									
140057163	LEDDownlightRc-P-HG R150-11.5W-DALI-4000	CFL 1x18W	11.5	1265	110	≤19	4000	≥ 80	0,45

Accessoires



140060646
LEDDownlightRc-P-HZ-Adapter-150-175



140061242
LEDDownlightRc-P-R150-Surface-Module-WH



549098001300
LEDDownlightRc-P EM-kit 1h

549098001400
LEDDownlightRc-P EM-kit 3h



542098030700
Junction-Box-WH

Artikel- en verpakkingsinformatie

Artikel			Doosverpakking			
Artikelcode	Artikelomschrijving	EU HS Code	Afmetingen (mm) (LxBxH)	Brutogewicht (kg)	EAN	st/doos
140057163	LEDDownlightRc-P-HG R150-11.5W-DALI-4000	94051190	200x200x103	0,73	6956712692672	1
140060646	LEDDownlightRc-P-HZ-Adapter-150-175	94059900	200x200x0.8	0,18	6956321894122	1
140061242	LEDDownlightRc-P-R150-Surface-Module-WH	94059900	222x222x280	2,35	6956321840655	1
542098001000	LEDTrunking DALI Power Supply	85044083	198x54x39	0,24	6945730496614	1
542098030700	Junction-Box-WH	85369010	43x103.4x26	0,06	6941408868684	1
549098001300	LEDDownlightRc-P EM-kit 1h	85044083	490x390x150	0,98	6941497709592	1
549098001400	LEDDownlightRc-P EM-kit 3h	85044083	490x390x150	1,08	6941497709585	1

Technische specificaties	
Levensduur (L70)	70.000 u
Levensduur (L80)	50.000 u
Aan-/Uit-cycli	100.000
Kleurconsistentie (SDCM)	3
Dimbaarheid	DALI
Bundelhoek	70°
Afwerking	Wit RAL9003
IP voorzijde	IP44
IP-klasse achterzijde	IP20
Slagvastheid	IK02
Beschermingsklasse	II
Risicogroep (EN 62471)	RG0 / RG1 (23W & 33W)
Voorschakelapparaat inbegrepen	Ja
Gloeidraadtest	650°C
Vermogensfactor	≥ 0,9

Elektrische aansluiting	
Frequentie	50/60 Hz
Nom. spanning	220-240 V
DC ingangsspanning	Zie catalogusbijlage Aansluitwaarden
230V Kabellengte	0.3 m

Materiaal eigenschappen	
Materiaal behuizing	Gegoten Aluminium
Materiaal optiek	Polycarbonaat

Toepassingscondities	
Bedrijfstemperatuur	-10-+40°C
Gebruikstemperatuur	+25°C
Opslagtemperatuur	-25-+50°C

5 JAAR GARANTIE



ENERGY

OPPLE Lighting
140057163

12
kWh/1000h

2019/2015

Maatschets (mm)

LEDDownlightRc-P-HG R150

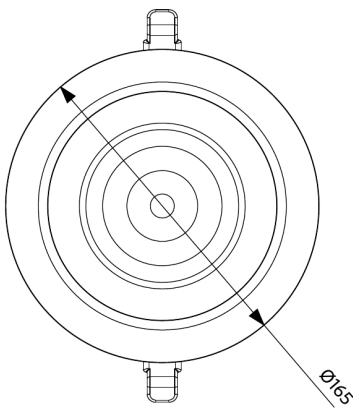

LEDDownlight Driver

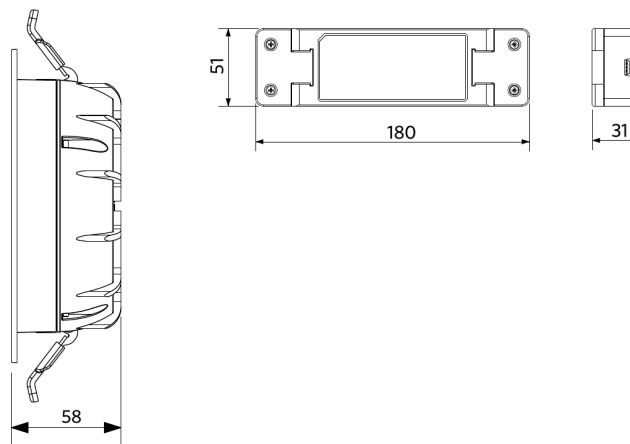

LEDDownlight Driver Tunable White

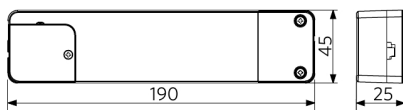

LEDDownlightRc-P-HG R150
LEDDownlightRc-P-R150-Surface-Module

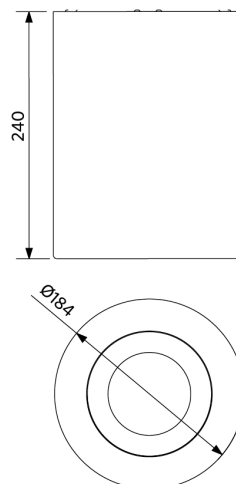

Fotometrische gegevens

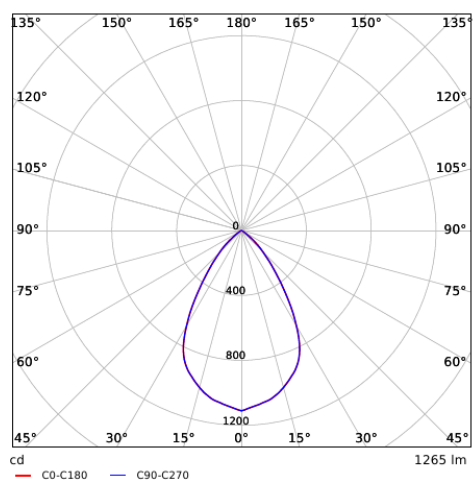

Tekening inbouwmaat (mm)

LEDDownlightRc-P-HG R150
Ø150

