

Installing the thermostat

Universal temperature control unit insert with touch display

Operating instructions

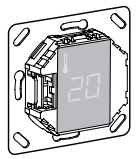

MTN5775-0000

Accessories

- MTN5775-0003 Floor Sensor
For operating the thermostat in floor and dual mode.

For your safety

DANGER
Risk of fatal injury due to electrical current
All work on the device should only be carried out by trained and skilled electricians. Observe the country-specific regulations.

Thermostat introduction

With the universal temperature control unit insert with touch display (referred to in the following as the **thermostat**), you can regulate room or floor temperature. The unit is operated using a touch display. The thermostat can be connected to floor heating systems, radiators or ambient heating systems.

Operating modes

The thermostat can be operated in three different modes:

- **Ambient air mode:**
The internal temperature sensor detects the room temperature. The thermostat controls the load, based on the room temperature.
- **Floor mode:**
The floor sensor detects the floor temperature. The thermostat controls the load, based on the floor temperature.
- **Dual mode:**
The internal temperature sensor monitors the room temperature and controls the load, based on the room temperature.
At the same time, the floor sensor monitors the floor temperature and limits this to the predefined maximum temperature value ("max Temp").
This mode is particularly recommended for parquet and laminate floors.

In all operating modes, you can connect an external time switch for temperature reduction (TR). The TR input can also be used for various functions according to the "PilotWire" specification:

Half wave:	Function:
None	No reduction
Both	Reduction
Positive	Controller OFF
Negative	Frost protection
Both (short pulse)	setpoint - 1 °C
Both (long pulse)	setpoint - 2 °C

Thermostat installation

In order for the thermostat to be operated in ambient air or dual mode, the thermostat must be installed in such a way that it is protected as far as possible against external influences and temperature fluctuations. This guarantees reliable detection of the room temperature.

The following should therefore be taken into account when considering the installation site:

- Minimum installation height: 1.5 m above the floor.
- Do not install too close to windows, doors or ventilation openings.

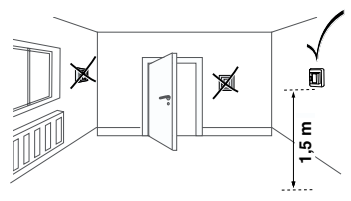

- Do not install above heaters or other heat sources.
- Do not cover or install behind curtains.
- Avoid direct sunlight and light from lamps.

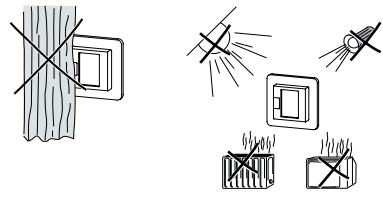

Floor sensor installation

In order to guarantee reliable operation in floor and dual mode, the floor sensor must be protected against external influences and temperature fluctuations.

The following should therefore be taken into account when considering the installation site:

- If possible, maintain a clearance of 1.0 m from walls and doors.
- Install sensor in the middle of the loops (see picture below).
- Place the floor sensor in a plastic tube with an inside diameter of 16 mm.

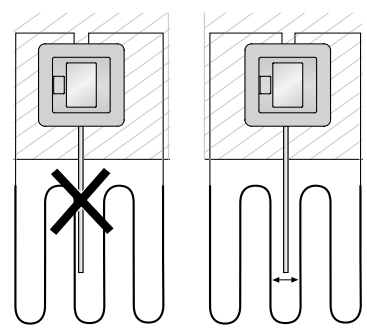

Wiring the thermostat

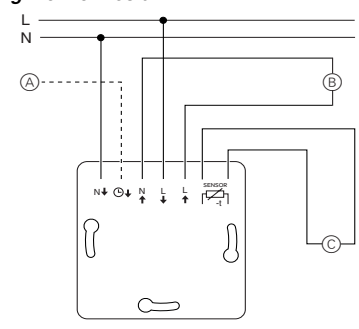

- (A) External time switch (TR) or "PilotWire"
- (B) Heat load/thermoelectric valve drive
- (C) Floor sensor

Mounting the thermostat and covers

- ① Install the thermostat in a flush-mounted box.
- ② Place the frame onto the insert.
- ③ Press in the snap ring until it presses against the frame.

i Selecting a central plate with switches allows you to disconnect both the device and the connected load from the network at both terminals.

i Once a central plate without a switch plate has been installed, the thermostat switch (S) is covered and can no longer be actuated. It is therefore important to make sure that the switch (S) has been pressed in (switch position "ON") before install the central plate.

- ④ Press on the central plate until it snaps into place.

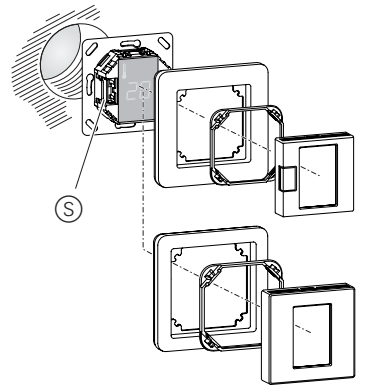

Removing the covers

- ① Using a suitable screwdriver, press on the marked points to loosen the central plate.

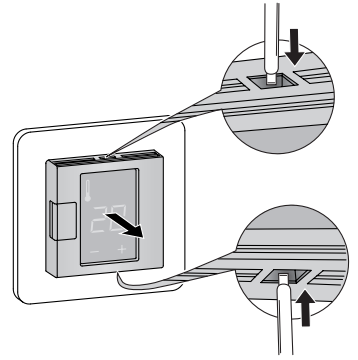

- ② Tilt the central plate forward and remove it.
- ③ Lift out the snap ring using a suitable screwdriver and remove it.

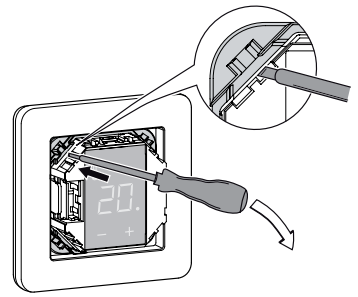

- ④ Remove the frame.

Starting up

Switching on the thermostat for the first time

- Central plate **with** switch: The thermostat can be switched on and off using the software shutdown and also using the switch.
- Central plate **without** switch: The thermostat can be switched on and off using the software shutdown.

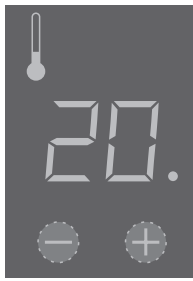

To switch off using the software shutdown,

- ① press „+“ and „-“ simultaneously,
- ② hold for 3 seconds,
- ③ keep pressing when „COdE“ is demanded,
- ④ thermostat shuts down.

Thermostat recovers from software switch shutdown by pressing „+“ or „-“.

i All the default settings shown when the device is switched on for the first time can be adjusted later on in the settings menu (see "Operating the thermostat").

Language pin code request

When the device is switched on for the first time, the display requests the language pin code. This ensures that the messages are displayed in the correct language.

Display	Meaning	Symbol
COdE	Enter language pin code	COdE

Press "+" until the correct language pin code is displayed.

The language pin codes are:

Language	PIN	Language	PIN
EN	11	NL	14
DE	12	ES	15
FR	13	PT	16
		Symbol	17

Accept your choice by pressing „+“ and „-“ simultaneously.

Operating mode display

The thermostat automatically detects when a floor sensor is connected and goes to the floor mode ("Floor"). If the floor sensor is not connected, it goes to the ambient air mode ("Air").

Also other factory settings are displayed now.

i If a floor sensor is connected, you can change from floor mode to dual mode at a later point (see "Operating the thermostat").

Operating the thermostat

Setting the temperature

i Heating the floor or the room to the desired temperature may take several hours. You should therefore wait a while before increasing the temperature.



- Select the desired room temperature by pressing "+" or "-".
- The desired room temperature is shown on the display.
- The blue dot (A) indicates that the heat load is warming up.

Changing the basic settings

i The thermostat automatically returns to the normal display if nothing is input in the settings menu for one minute.

i The settings are displayed one after another when the settings menu is selected.

- Select the desired value by pressing "+" or "-".
- Confirm your selection by pressing "+" and "-" simultaneously.

- ① Hold down "+" and "-" together for three seconds to activate the **Settings menu**.
- ② Enter the **language pin code** and confirm.

i The language pin codes are given in the chapter "Starting up".

Display	Meaning	Symbol
COdE	Enter language pin code	COdE

- ③ Select the desired **operating mode** and confirm.

Display	Meaning	Symbol
FLOOR	Select operating mode	F1
Air		F2
DUAL		F3

- ④ Set the **maximum temperature** and confirm.

i You can set the maximum temperature in the ambient air and floor modes. In dual mode, this value limits the temperature of the floor in order to protect materials which are sensitive to extreme temperatures.

The factory setting for the maximum temperature is

- 35 °C in Air mode
- 40 °C in Floor mode and
- 27 °C in Dual mode (Floor max.).

Display	Meaning	Symbol
SAFE	Set the maximum temperature in °C.	SAFE
35		35

- ⑤ Set the **reduced temperature** and confirm.

i Temperature reduction (TR) only occurs if an external timer (e.g. PilotWire) is connected.

Display	Meaning	Symbol
SEtBAC	Set the reduced temperature in °C.	SE
-5		-5

The factory setting for the temperature reduction is -4 °C.

What should I do if there is a problem?

Error outputs on the display

Display	Meaning	Symbol
Error	Incorrect input, general error	EE
Error HEAT	Internal overheating in thermostat	E1
Error FLOOR	Floor sensor not recognised	E2

Connected load is not heating

- Observe the message on the display: If "Err Temp" or "Err Sensor" are shown, load is not connected. Investigate the cause of this error.
- Check the power supply.
- Switch the thermostat off and back on again.
- Check the "SAFE"-value setting. The value may be too low.
- Check the load.
- If using an external time control device, check the control voltage.

Display is blank:

- Check the power supply.
- Switch the thermostat off and back on again.

Technical data

Nominal voltage:	230 V AC, 50 Hz
Nominal load (ohmic):	16 A
Nominal load (inductive):	1 A, cos φ = 0.6
Mode of operation:	1 C
Standard:	DIN 60730-2-9
Type of housing protection:	IP 20
Overvoltage/overheating protection:	Electronic
Rated surge voltage:	4 kV
Operating temperature:	-10 °C to +35 °C
Setting range	
Room temperature:	+5 °C to +35 °C
Floor temperature:	+5 °C to +50 °C
Reduction:	+/- 0...9 °C from set temperature
Display precision:	1 °C

Schneider Electric Industries SAS

If you have technical questions, please contact the Customer Care Center in your country.

www.schneider-electric.com

This product must be installed, connected and used in compliance with prevailing standards and/or installation regulations. As standards, specifications and designs develop from time to time, always ask for confirmation of the information given in this publication.