

## LED Slim Panel Performer

Panel Model Name	Luminaire Model Name	CCT	kg
LED PL-RC-S5 SQ595-34W U19-PL 01	LED PL-RC-S5 SQ595-34W U19 01	4000K	3.0kg
	LED PL-RC-S5 SQ595-34W Dim-D U19 01	4000K	3.0kg
	LED PL-RC-S5 SQ595-34W Dim-B U19 01	4000K	3.0kg
LED PL-RC-S5 SQ620-34W U19-PL 01	LED PL-RC-S5 SQ620-34W U19 01	4000K	3.2kg
	LED PL-RC-S5 SQ620-34W Dim-D U19 01	4000K	3.2kg
	LED PL-RC-S5 SQ620-34W Dim-B U19 01	4000K	3.2kg
LED PL-RC-S5 RE295-34W U19-PL 01	LED PL-RC-S5 RE295-34W U19 01	4000K	3.0kg
	LED PL-RC-S5 RE295-34W Dim-D U19 01	4000K	3.0kg
	LED PL-RC-S5 RE295-34W Dim-B U19 01	4000K	3.0kg
* Accessories should be purchased separately.	542098006900*	LEDPanel-S4-Suspension-Kit	0.16kg
	140057770*	LEDPanelRc-SI-Mounting-Springs-595	0.13kg

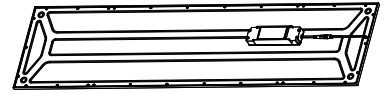
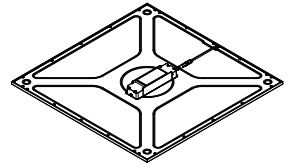

Type	A(mm)	B (mm)	C(mm)
SQ595	595	595	9
SQ620	620	620	
RE295	295	1195	

Type	L1(mm)	L2(mm)	L3(mm)
SQ595	500	500	500
SQ620			
RE295			

Do not cover with insulation material

BLE version, Do not put in a closed metal or cement space.

### TOUCH DIM FUNCTIONALITY (For DALI2 System)

Wrong connection

Good connection

Function	Contact Duration	Reaction
Ignore	< 50ms	Nothing
Short Push	50-500ms	Turn on or off
Long Push	> 500ms	Dimming up or down
Synchronisation	10s	Go to SYNC level, 50%
	20s	Go to SYNC level, 100%

Touch Dim Terminal Consumption: Typical 3mA(220V).

Warning: TD function and DALI function can't be used at the same time, avoid damaging the DALI system by high voltage.

Terminal block not included.  
Installation may require advice from a qualified person.  
Only use suitable connection boxes with internal terminal blocks conform to EN60998-2-1 or EN60998-2-2. Terminal should be capable for at least 450V 16A, 0.75mm<sup>2</sup> wiring.

Luminaires not suitable for covering with thermally insulating material.  
Leuchten sind nicht mit thermisch isolierenden Materialien abzudecken.

In case of damage to the wire, it has to be replaced only by the manufacturer, distributor or by an expert, to avoid risks.  
Caution: Any operation on LED module is forbidden while power-on.  
Zur Vermeidung von Risiken müssen defekte Leitungen ausschließlich vom Hersteller, Inverkehrbringer oder Fachmann ausgetauscht werden.  
Achtung: In Betrieb ist keine Arbeit am LED-Modul erlaubt.

For non-user replaceable light sources.  
The light source contained in this luminaire shall only be replaced by the manufacturer or his service agent or a similar qualified person.

Suzhou Oppl Lighting Co., Ltd.  
215200  
East Side, Fenyang Road,  
Fenhu Economic Development Zone,  
Wujiang City, Jiangsu Province,  
P.R.China

Oppl Lighting BV  
Meerenakkerweg 1.11  
5652 AR Eindhoven  
The Netherlands  
service@opple.com  
www.opple.com  
250053338001

## Recessed Mounting (Lay-in)

For DALI/10V

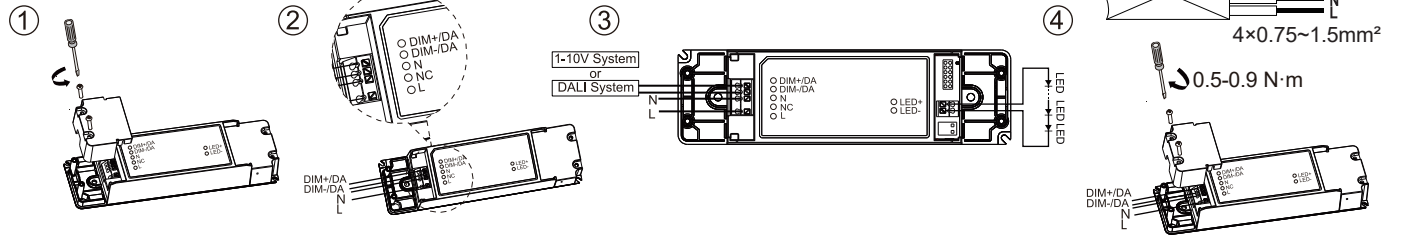

For BLE

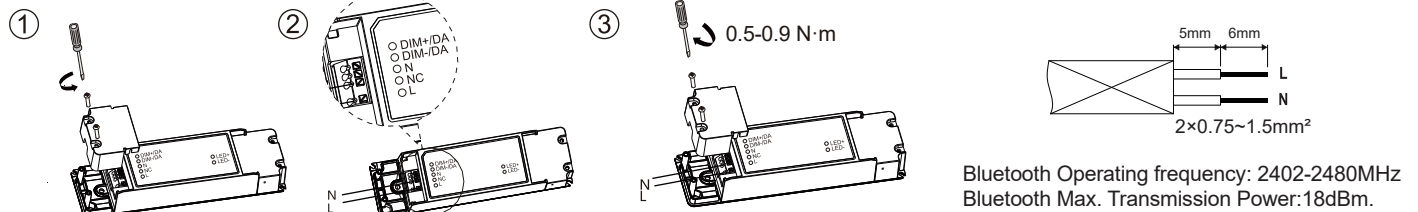

For Static

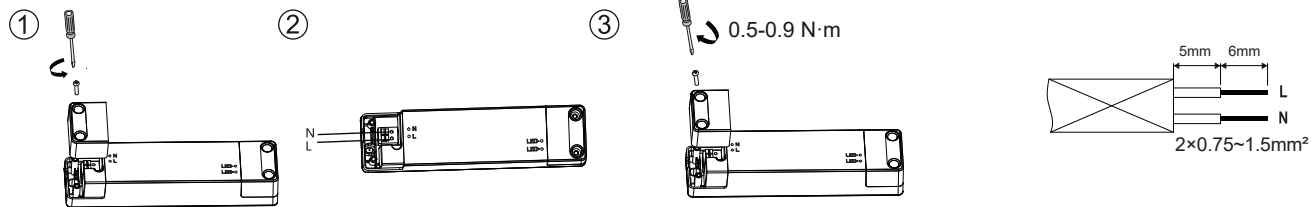

## Suspension (Suspension kit to be purchased separately)

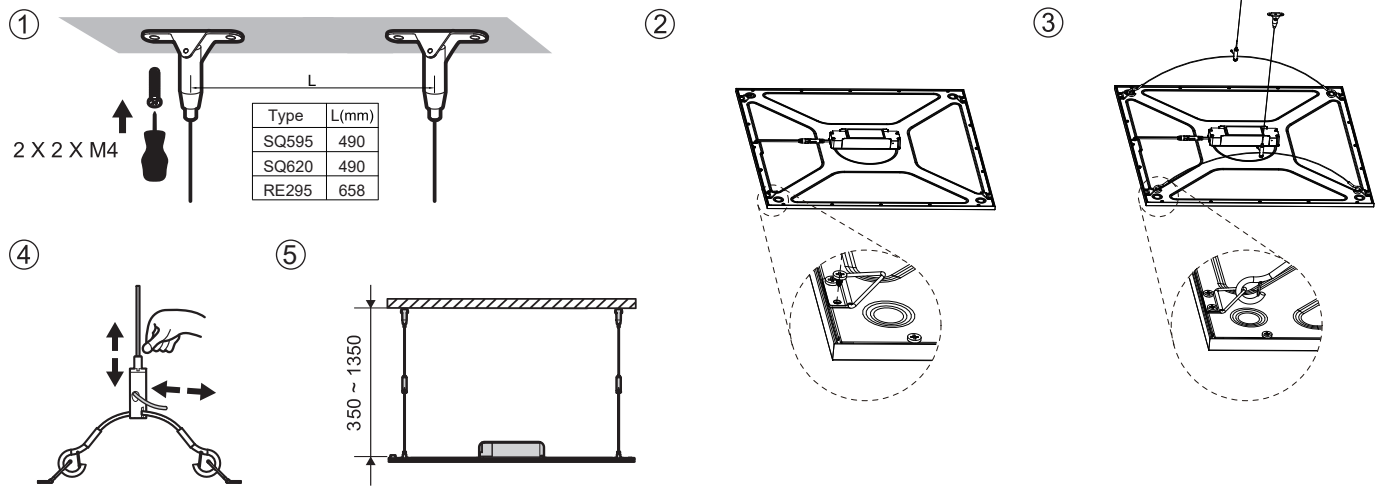

## Recessed Mounting (Clips)

For Static/DALI/10V

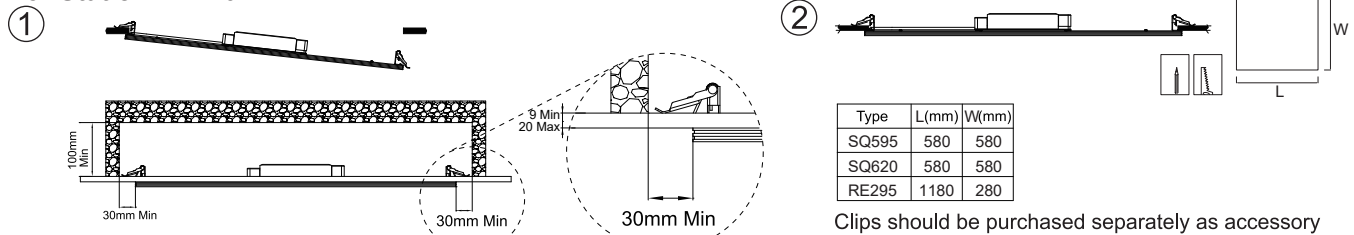

For BLE Do not put in a closed metal or cement space.

