

# INSTRUCTION

Signcube Midi  
672299.002.89



≈ 220 - 240 V 0/50/60 Hz IP 40 IK03



5 x 2,5 mm<sup>2</sup>

2,50 mm<sup>2</sup>



Dauerschaltung / maintained  
=> -5 °C ... + 25 °C

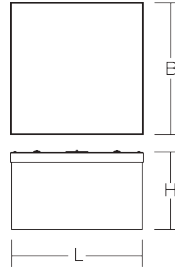

L 315, B 315, H 187

2,72 kg



$\Phi$  [lm]

$P_{\text{LED}}$  [W]

$\Phi$  [lm]

$P_{\text{LED}}$  [W]

$P_{\text{LED}}$

LED

400

7,3

400

6,7

4 x 1,8 W

CCT [K]

CRI

$\angle$  [m]

RG

EEK

4000

70

30

RG 0

D

$I_{\text{max}}$  /  $I_{\text{max}}/2$   
T50

B10  
[St.]

B16  
[St.]

C10  
[St.]

C16  
[St.]

$\cos \varphi$

5 A / 50  $\mu$ s

31

50

52

85

0,95

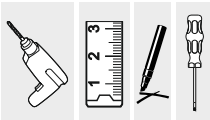



### Allgemeine Sicherheitshinweise

- Der elektrische Anschluss muss ordnungsgemäß nach geltenden Normen und den nationalen sowie internationalen Sicherheits- und Unfallverhütungsvorschriften erfolgen.
- Beschädigte Leuchten dürfen nicht betrieben werden.
- Keine Haftung für Schäden durch unsachgemäßen Einsatz.
- Bei Instandsetzung nur Originalteile verwenden.
- Tragfähigkeit der Decke und Befestigungselemente sicherstellen.

### Betrieb der Leuchte

- Die unzulässigen Umgebungstemperaturen reduzieren die Lebensdauer der Leuchte, im Extremfall droht der Frühausfall.
- Zur Vermeidung von EMV-Problemen die Durchgangsverdrahtung nicht entlang der Leuchtenverdrahtung führen.
- Steuereingänge von dimmbaren Leuchten mit handelsüblichen für Netzspannung geeigneten Leitungen anschließen.

### Manipulationen unserer Produkte sind unzulässig

Veränderung, Umarbeitung, Umkennzeichnung von Produkten sowie deren Verpackung sind unzulässig und verletzen u.a. unsere eingetragenen Warenzeichenrechte. Solche Modifikationen können technische Eigenschaften unserer Produkte negativ beeinflussen, diese zerstören und möglicherweise Folgeschäden an anderen Objekten verursachen. Für durch derartige Modifikationen verursachte Schäden kann der Hersteller in keinem Fall verantwortlich gemacht werden.



### General Safety Information

- Electric connection must be appropriate according to all applicable standards and other national and international safety and accident prevention regulations.
- Damaged luminaires must not be operated.
- No liability is accepted for damages resulting from improper use.
- Use genuine parts only for repair.
- Ensure stability of the ceiling and fastening elements.

### Operation of the luminaire

- Exceeding the permissible ambient temperature will reduce the luminaire's lifecycle, resulting in premature failure in extreme cases.
- Avoid ESD problems by not routing feed-through wiring directly along the wiring of the luminaire.
- Connect control inputs of dimmable luminaires with standard cables suitable for power supply voltage.

### Manipulation of our products is not permitted

Modifications, reworking, re-labelling of products as well as their package is not permitted and infringes, amongst others, our registered trademark rights. Such modifications may affect technical properties of our products, damage them and possibly cause consequential damage to other objects. The manufacturer shall not be responsible under any circumstances for damage caused by such modifications.



 Bei Fragen zu unseren Symbolen, besuchen Sie folgende Webseite:  
If you have any questions about our signs, visit the following website:



[https://www.rzb.de/fileadmin/assets/downloads/PDF/RZB\\_Symbolklaerung.pdf](https://www.rzb.de/fileadmin/assets/downloads/PDF/RZB_Symbolklaerung.pdf)

**EEK** 

Dieses Produkt enthält eine Lichtquelle der Energieeffizienzklasse D entsprechend Verordnung (EU) 2019/2015

This product contains a light source of energy efficiency class D according to regulation (EU) No 2019/2015

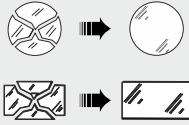
 Jede zersprungene Schutzabdeckung ist zu ersetzen. DIN EN 60598

Replace any cracked protective shield. IEC DIN EN 60598

 Die Lichtquelle dieser Leuchte darf nur vom Hersteller oder einem von ihm beauftragten Servicetechniker oder einer vergleichbar qualifizierten Person ersetzt werden. DIN EN 60598-1 / IEC 60598-1

The light source contained in this luminaire shall only be replaced by the manufacturer or his service agent or a similar qualified person. DIN EN 60598-1 / IEC 60598-1

 Zur Verwendung in Anlagen nach EN 50172 / DIN VDE 0108-100

For installation according to EN-50172 / DIN VDE 0108-100



## Einteilung Notleuchten

*	**	***	****
---	----	-----	------

Veränderungen am Auslieferungszustand der Leuchte sind gemäß DIN EN 60598-2-22 auf dem Typenschild zu kennzeichnen.

## Classification Emergency Lighting

*	**	***	****
---	----	-----	------

Modifications to the delivery condition of the luminaire must be documented on the product label accordingly to IEC 60598-2-22.

*	Typ (1-stellig)	Type (1-digit)
X	Einzelbatterie	Self-Contained
Z	Zentralbatterie	Central Supply

**	Betriebsart (1-stellig)	Operating Mode (1-digit)
0	Notleuchte Bereitschaftsschaltung	Emergency Lighting non-maintained
1	Notleuchte Dauerschaltung	Emergency Lighting maintained
2	Kombinierte Notleuchte Bereitschaftssch.	Combi. Emergency Lighting non-maintained
3	Kombinierte Notleuchte Dauerschaltung	Combined Emergency Lighting maintained

***	Einrichtungen (max. 7-stellig)	Installation (max. 7-digit)
A	manuelle Prüfeinrichtung	Manual Test Device
B	Fernschalter für Ruhe-Zustand	Including Remote Rest Mode
C	Fernausschaltemöglichkeit	Including Inhibiting Mode
D	Arbeitsstätten m. besonderer Gefährdung	High-Risk Task-Area Luminaire
E	Lampe oder Batterie nicht austauschbar	With non-replaceable Lamps or Battery
F	automatische Prüfeinrichtung	Automatic Test Device
G	von innen beleuchtetes Sicherheitszeich.	Inside illuminated safety sign

****	Betriebsdauer (2/3-stellig) (nur bei Einzelbatterie)	Duration Time (2/3-digit) (only for self-contained)
60	Betriebsdauer 60 Minuten	Duration Time 60 Minutes
180	Betriebsdauer 180 Minuten	Duration Time 180 Minutes
480	Betriebsdauer 480 Minuten	Duration Time 480 Minutes

## Anschlussplan / Wiring diagram

### AC-Control 985487

Überwachungsbaustein / Monitoring module

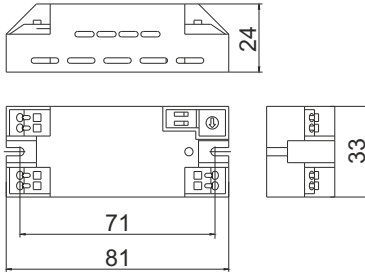

### Technische Daten / Technical Data:

Gehäuse / Housing:

Kunststoff, weiß / Plastic, white

Eingangsspannung / Voltage:

230V AC ( $\pm 10\%$ )

220V DC ( $\pm 20\%$ )

Umgebungstemperatur / Ambient temperature:

-10 ... 55 °C

Einschaltstrom / Inrush current:

40 A / 200 ms

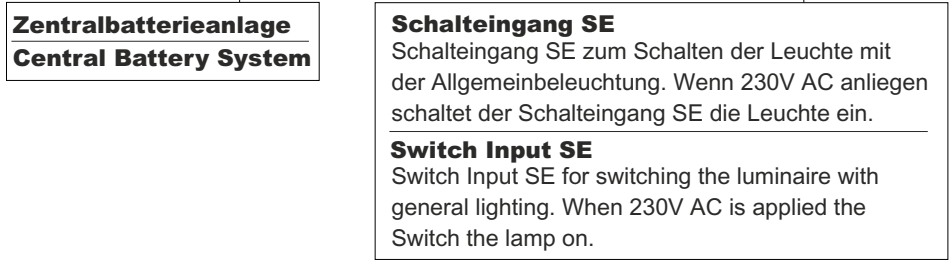
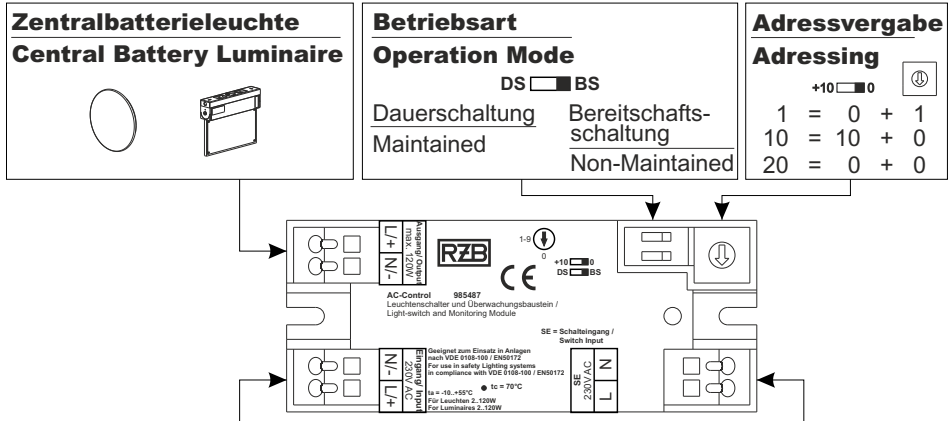



## Hinweise zum Aufbringen der Folien

### How to apply the legend to the cover

- |    |  |  |
|----|--|--|
| !  |  | <u>Folie bei Raumtemperatur aufkleben</u><br>Affix the foil at room temperature  |
| 1. |  | <u>Oberfläche säubern (fett- und staubfrei)</u><br>Clean the surface (it must be free from dust and grease)  |
| 2. |  | <u>Schutzpapier (bedruckte Seite) von Klebeseite der Folie abziehen</u><br>Remove the protective paper (printed side) from the self adhesive legend  |
| 3. |  | <u>Folie in entspanntes Wasser tauchen (z.B. Wasser mit Spülmittel)</u><br>Soak the self-adhesive legend in mild washing-up liquid water   |
| 4. |  | <u>Klebefolie auf die Abdeckung auflegen und ausrichten</u><br>Apply the self-adhesive legend to the diffuser properly   |
| 5. |  | <u>Mit einem Rakel oder der Hand alle Luft- und Wassereinschlüsse zwischen Folie und Abdeckung zu den Seiten hinwegstreichen</u><br>Flatten the legend ad sweep away all air and watterbubbles between the foil and the diffusor by hand or with a spreading knife |
| 6. |  | <u>Übertragungspapier, falls vorhanden, vorsichtig abziehen</u><br>Remove carefully transfer paper if there is one   |
| 7. |  | <u><b>ACHTUNG: Abdeckungen nur mit abgetrockneter Folie montieren!</b></u><br><u><b>WARNING: Only a diffuser with a dried legend must be attached to the fitting!</b></u>  |

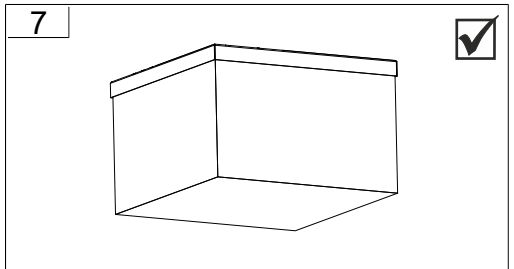
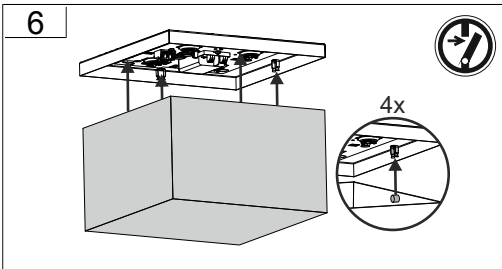
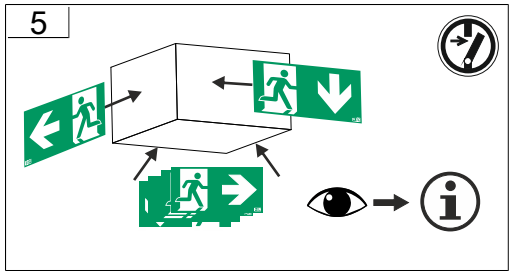
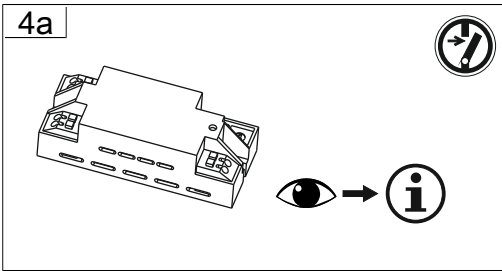
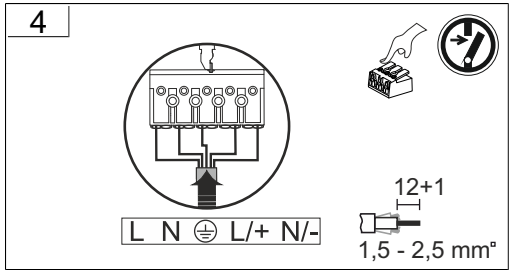
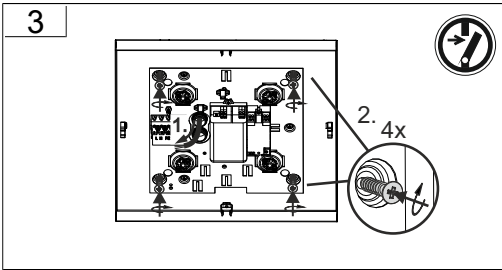
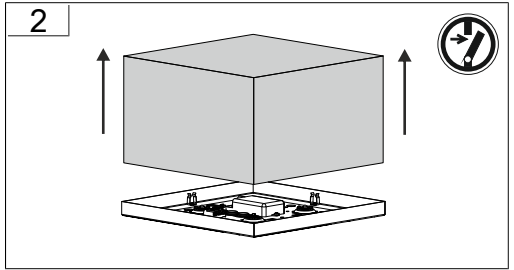
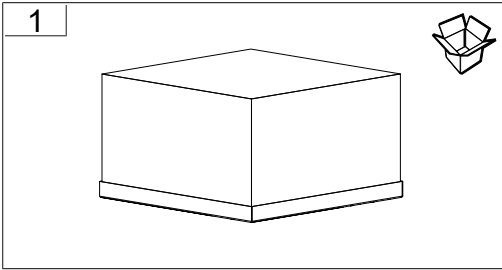

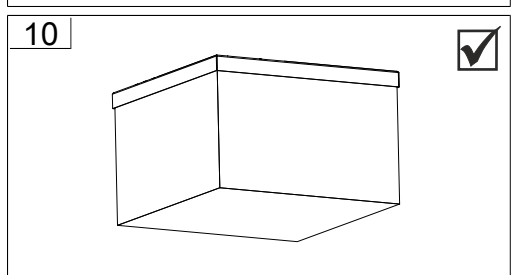
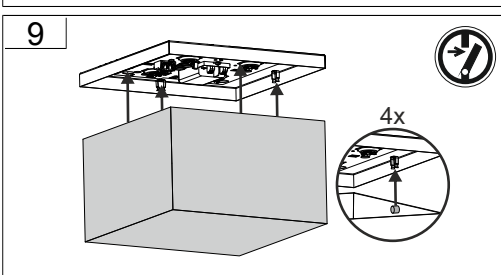
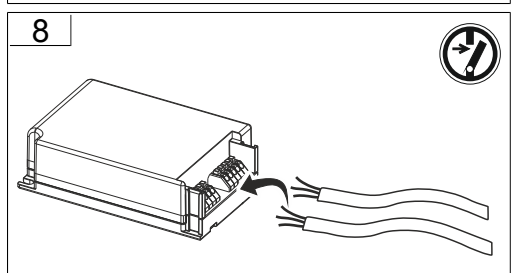
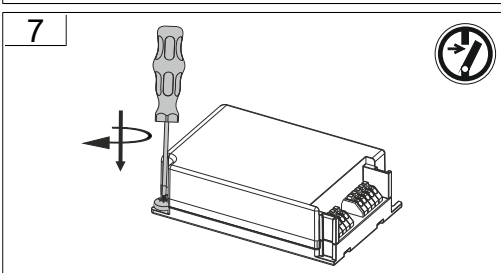
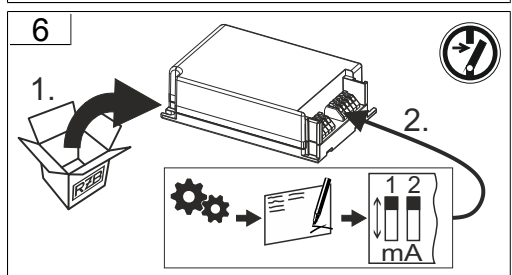
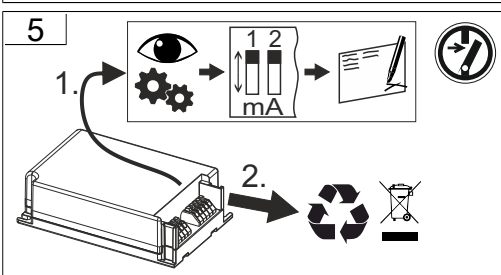
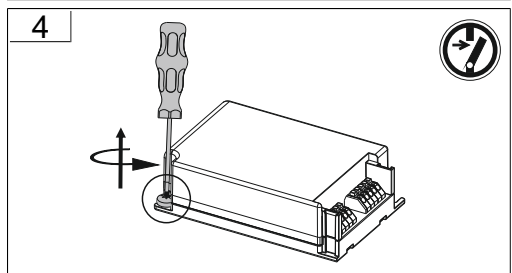
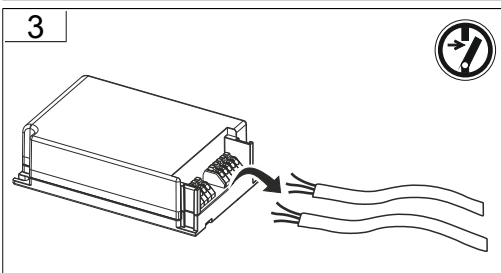
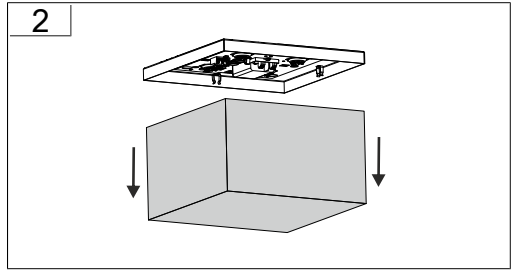
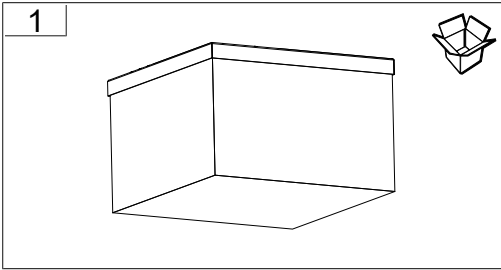



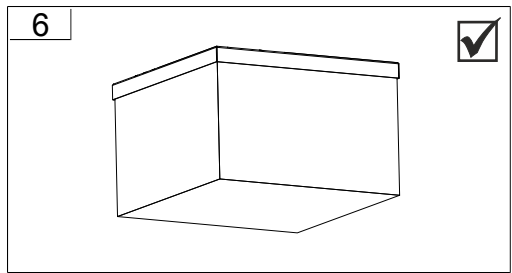
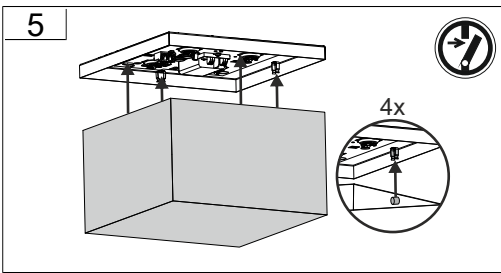
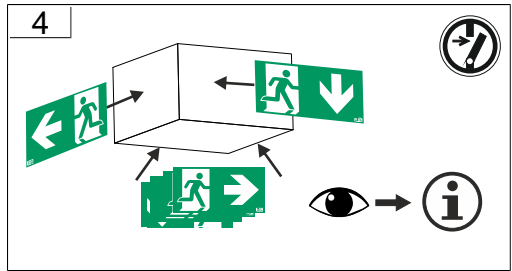
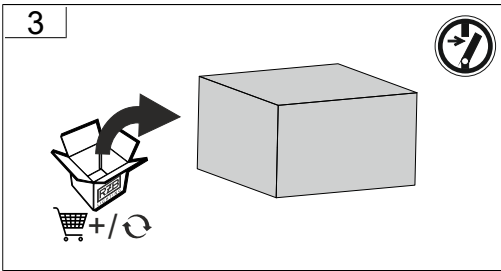
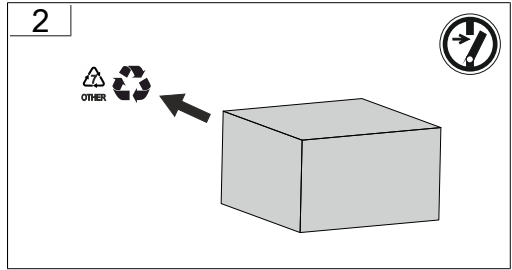
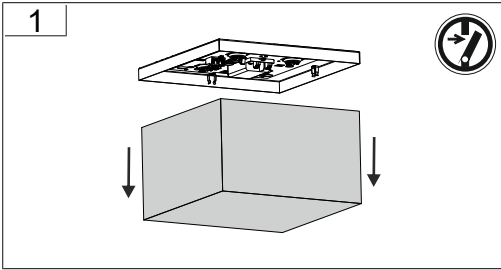

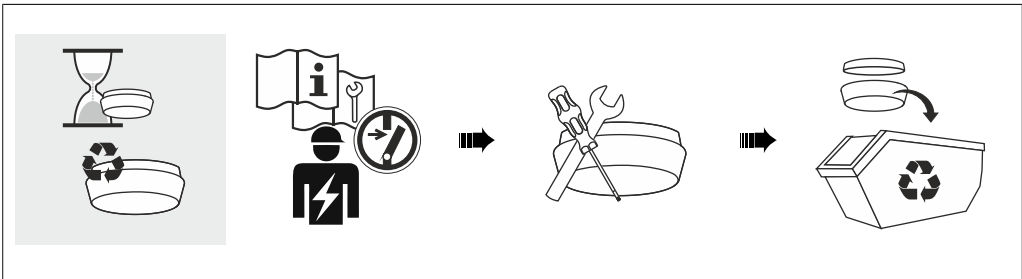
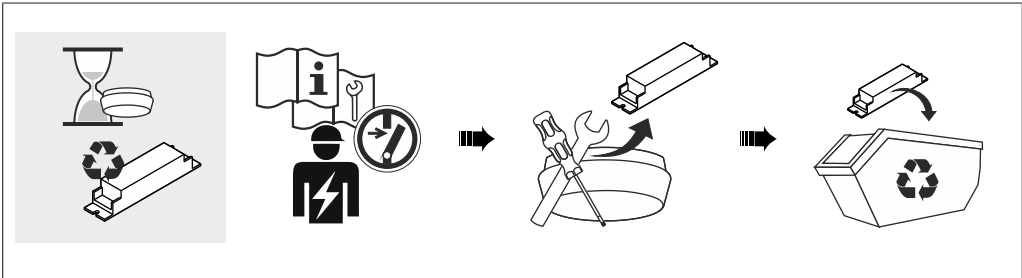
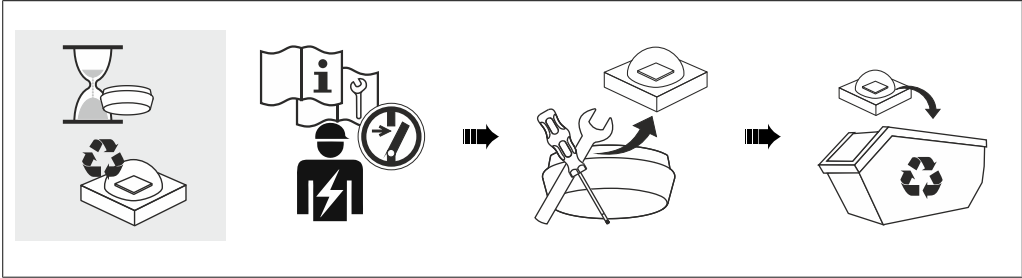



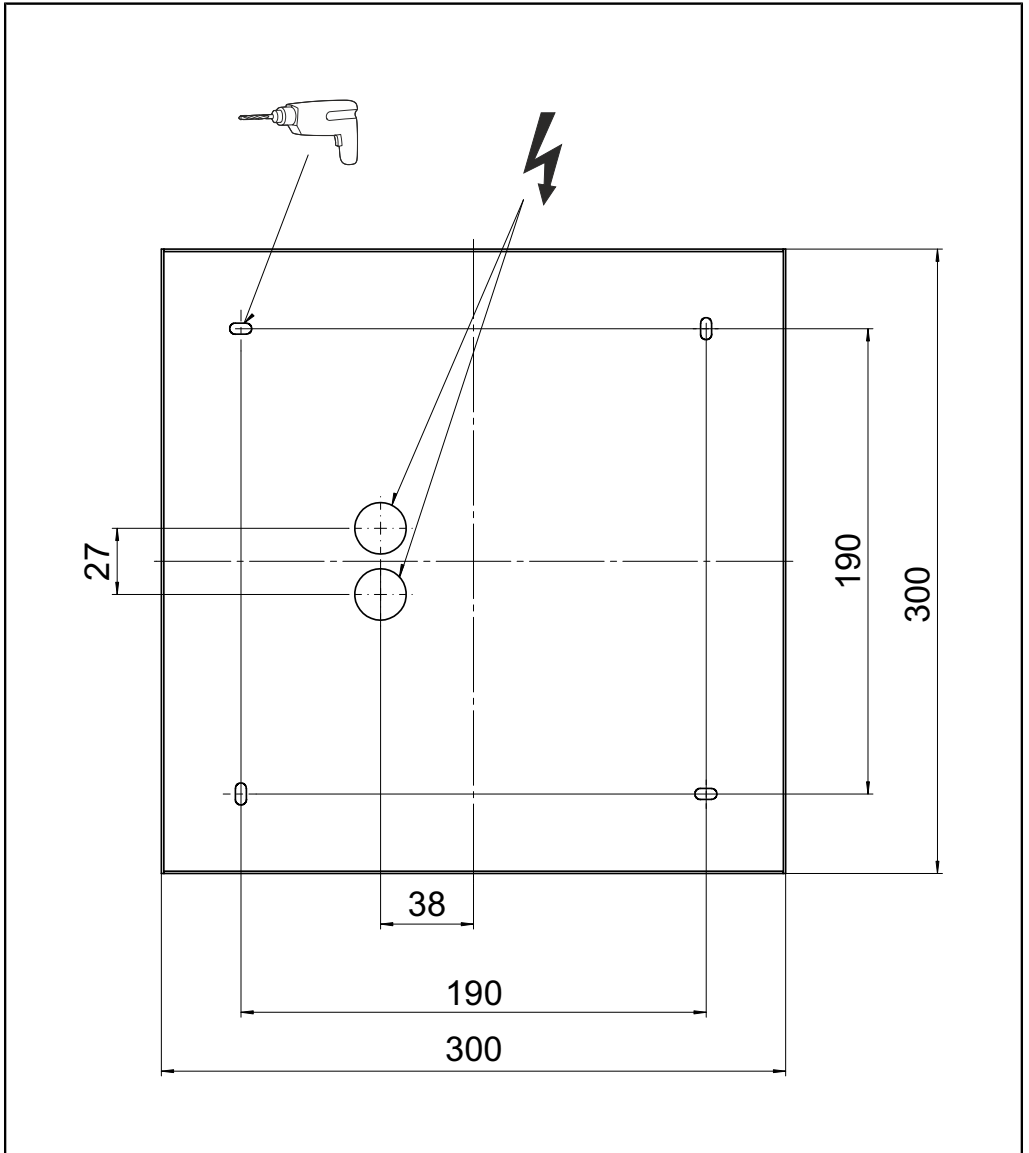





RZB - Rudolf Zimmermann, Bamberg GmbH

 Rheinstraße 16, 96052 Bamberg

 0951/7909-0

 0951/7909-198

 [info@rzb-leuchten.de](mailto:info@rzb-leuchten.de)