

Product Data Sheet

GW10572A

CHORUSMART - Domestic range



Wide range of control devices, sockets for power supply (conforming to national and international standards) signal pick-up, climate control, comfort management, technical alarm signalling and emergency lighting management. The ChoruSmart modular devices are available in five colours, glossy white, satin white, natural beige, satin black and lacquered titanium and in various sizes from 1/2, 1, 2 and 3 modules. Thanks to the mounting supports for rectangular, square and round boxes, endless combinations can be created with the ChoruSmart range of plates.

Category	Dimmers	Colour	Glossy white
Wiring terminals	With screw	Standard	EN 60669-2-1; 2014/35/EU; 2014/30/EU
Supply voltage	230V ac - 50/60 Hz	Terminal tightening capacity stranded cables (mm ²)	Max. 1,5
Terminal tightening capacity solid cables (mm ²)	Max. 2,5	No. modules	1
230V incandescent/halogen lamps	40 ÷ 300W	230V LED lamps	5 ÷ 150W (max 10 lamps)
Halogen lamps 12Vac with winding transf.	40 ÷ 300W	LED lamps 12Vac with electronic transf.	40 ÷ 300W (max 2 transf.)
LED colour	Orange	Electrocod	0781
Material	Technopolymer		

DIMENSIONAL

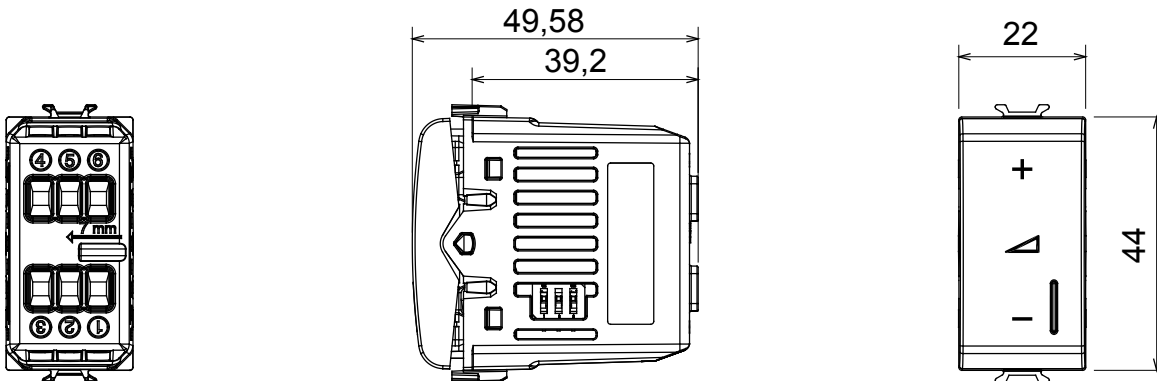

STANDARDS/APPROVALS

