

# PRODUCT DATASHEET

## TR SP ZOOM DIM D85 25 W 3000 K 97R WT

TRACKLIGHT SPOT ZOOM DIM | Dimmable 3-phase tracklight spot with mechanical zoom lens



### Areas of application

- Direct replacement for luminaires using HID lamps
- Accent lighting
- Galleries, museums
- Fashion shops, accessories shops
- Shops, changing rooms, shop windows
- Hotels, restaurants, shops

### Product benefits

- Dimmable 3-phase tracklight spot with mechanical zoom lens
- Included 3-phase adapter compatible with common tracks (GLOBAL, EUTRAC, POWERGEAR, STAFF, NORLUX, NUCO, NORDIC)
- No distraction of attention from the illuminated objects thanks to reduced design
- Low flicker light thanks to special electronic control gear
- 5 years guarantee

### Product features

- Mechanical zoom lens with a beam angle of 15 ° to 55 °
- Dimmable (7% - 100%) via slider potentiometer directly on each luminaire
- Excellent color rendering index CRI 97
- Color rendering index R<sub>a</sub>9: > 90
- Initial color consistency: ≤ 4 SDCM
- Rotation angle: 350°, tilt angle: 90°
- Follows the unified LEDVANCE design language (SCALE design)
- Robust die-cast aluminum housing



- Available in matt white (like RAL9016), matt black (like RAL9004)
- Luminaire efficacy: up to 70 lm/W

## TECHNICAL DATA

### Electrical data

|   |                       |
|---|-----------------------|
| Nominal wattage   | 25.00 W               |
| Nominal voltage   | 100...240 V           |
| Mains frequency   | 50...60 Hz            |
| Nominal current   | 120 mA                |
| Inrush current  | 40 A                  |
| Inrush current time $T_{h50}$                               | < 50 $\mu$ s          |
| Max. number of luminaires per miniature circuit breaker B16 | 37                    |
| Max. number of luminaires per miniature circuit breaker C10 | 30                    |
| Max. number of luminaires per miniature circuit breaker C16 | 48                    |
| Power factor $\lambda$                                      | > 0.90                |
| Total harmonic distortion                                   | < 10 %                |
| Protection class  | I                     |
| Operating mode  | Integrated LED driver |

### Photometrical data

|  |                           |
|--|---------------------------|
| Luminous flux                                | 1500 lm                   |
| Luminous efficacy                            | 60 lm/W                   |
| Color temperature                            | 3000 K                    |
| Light color (designation)                    | Warm White                |
| Color rendering index Ra                     | 97                        |
| Standard deviation of color matching         | $\leq 4$ sdc <sub>m</sub> |
| Luminous intensity                           | -                         |
| Flickering metric (Pst LM)                   | -                         |
| Stroboscope effect metric (SVM)              | -                         |
| Photobiological safety group acc. to EN62778 | RG1                       |
| Beam angle                                   | 15°... 55°                |

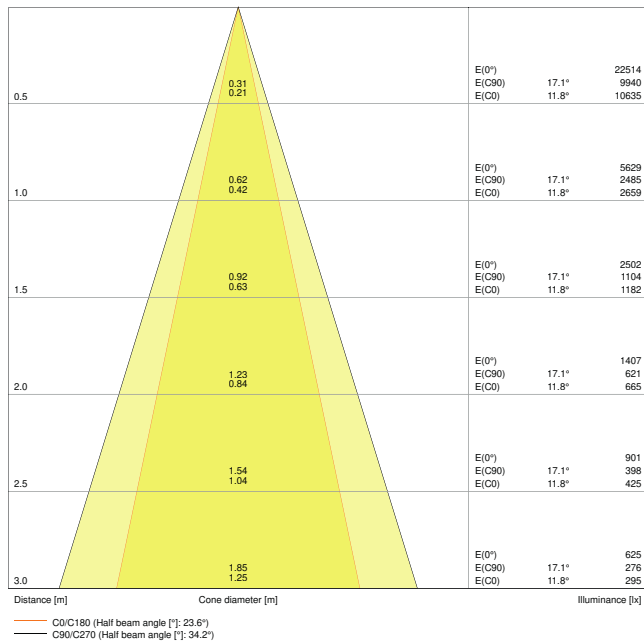

TR SP ZOOM D85 25W 3000K DIM 97R WT 25DEG

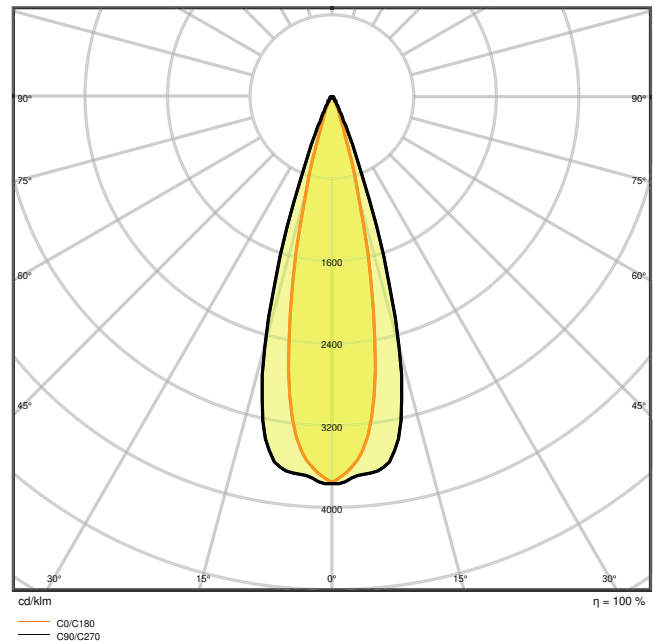

TR SP ZOOM D85 25W 3000K DIM 97R WT 25DEG

Dimensions & Weight

|                |           |
|----------------|-----------|
| Diameter       | 85.00 mm  |
| Length         | 93.00 mm  |
| Height         | 265.00 mm |
| Product weight | 1025.00 g |

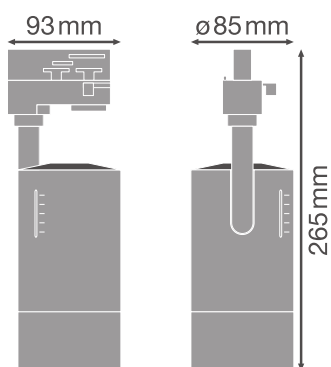

TR SP ZOOM D85

Materials & Colors

|  |                    |
|--|--------------------|
| Product color                              | White              |
| Housing color                              | White              |
| Body material                              | Aluminum           |
| Cover material                             | Polycarbonate (PC) |
| Light emitting surface material            | Polycarbonate (PC) |
| Glow Wire Test according to IEC 60695-2-12 | 850 °C             |
| Mercury content                            | 0.0 mg             |

### Application & Mounting

|  |                  |
|--|------------------|
| Ambient temperature range              | -20...+40 °C     |
| Type of connection                     | Adapter, 3-phase |
| Type of protection                     | IP20             |
| Protection class IK (shock resistance) | IK03             |
| Dimmable                               | Yes              |
| Type of dimming                        | 1-10V            |
| Mounting type                          | Surface          |
| Mounting location                      | Mounting track   |
| Application environment                | Indoor           |
| Adjustable                             | Yes              |
| With light source                      | No               |

### Lifespan

|                            |                       |
|----------------------------|-----------------------|
| Lifespan L70/B50 at 25 °C  | 50000 h <sup>1)</sup> |
| Lifespan L80/B10 at 25 °C  | 35000 h <sup>1)</sup> |
| Lifespan L80/B50 at 25 °C  | 35000 h               |
| Lifespan L90/B10 at 25 °C  | 25000 h               |
| Number of switching cycles | 100000                |

<sup>1)</sup> t[h]: L70 / B50 @ 25 °C (Ta), t[h]: L80 / B10 @ 25 °C (Ta), t[h]: L90 / B10 @ 25 °C (Ta)

### Control gear

|                             |           |
|-----------------------------|-----------|
| ECG - Output voltage        | 27...42 V |
| ECG - Output ripple current | < 10 %    |

### Certificates & Standards















|  |                                       |
|--|---------------------------------------|
| Standards  | CE / CB / ENEC / TÜV SÜD / EAC / RoHS |
| Luminaire with limited surface temperature, "D sign" | No                                    |



|                                  |                 |
|----------------------------------|-----------------|
| Ball shot safe                   | No              |
| Replaceable light source (EPREL) | Not replaceable |

### Safety advice

- All electrical connections must be made by a qualified person.
- Caution, risk of electric shock.

### DOWNLOAD DATA

| Documents and certificates   |  | Document name                              |
|--|--|--|
|    | User instruction / safety instructions | TRACKLIGHT SPOT ZOOM D85                   |
|    | User instruction / safety instructions | LEDVANCE TRACKLIGHT SPOT ZOOM 25W 3000K WT |
|    | Legal information                      | LS Insert TR SP ZOOM                       |
|   | Legal information                      | TRACKLIGHT SPOT ZOOM D85                   |
|  | Legal information                      | Informationstext 18 Abs 4 ElektroG         |
|  | Declarations of conformity             | CE declaration TR SP ZOOM                  |
|  | Declarations of conformity UKCA        | TRACK SP                                   |
| Photometric and lighting design files  |  | Document name                              |
|  | IES file (IES)                         | TRACKLIGHT SPOT ZOOM                       |
|  | LDT file (Eulumdat)                    | TR SP ZOOM D85 25W3000K DIM 97R WT         |
|  | ULD file (DIALux)                      | TR SP ZOOM D85 25W-3000K DIM               |
|  | ROLF file (RELUX)                      | TR SP ZOOM D85 25W-3000K                   |
|  | UGR file (UGR table)                   | TR SP ZOOM D85 25W 3000K DIM 97R WT 25DEG  |
|  | Light distribution curve type cone     | TR SP ZOOM D85 25W 3000K DIM 97R WT 25DEG  |
|  | Light distribution curve type polar    | TR SP ZOOM D85 25W 3000K DIM 97R WT 25DEG  |

| CAD/BIM files  |              | Document name        |
|--|--------------|----------------------|
|  | BIM Revit 3D | TRACKLIGHT SPOT ZOOM |
|  | CAD STEP 3D  | TR SPOT ZOOM         |

| Tender texts   |                  | Document name                                      |
|--|------------------|--|
|  | Tender documents | TRACKLIGHT SPOT ZOOM DIM D85 25 W 3000 K 97R WT-EN |

**LOGISTICAL DATA**

| Product code  | Packaging unit (Pieces/Unit) | Dimensions (length x width x height) | Gross weight | Volume                |
|---------------|------------------------------|--------------------------------------|--------------|-----------------------|
| 4058075335769 | Folding box<br>1             | 120 mm x 120 mm x 300 mm             | 1146.00 g    | 4.32 dm <sup>3</sup>  |
| 4058075335776 | Shipping box<br>4            | 502 mm x 137 mm x 335 mm             | 4902.00 g    | 23.04 dm <sup>3</sup> |

The mentioned product code describes the smallest quantity unit which can be ordered. One shipping unit can contain one or more single products. When placing an order, for the quantity please enter single or multiples of a shipping unit.

**ADDITIONAL CATALOG INFORMATION**

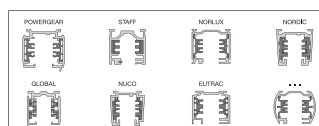
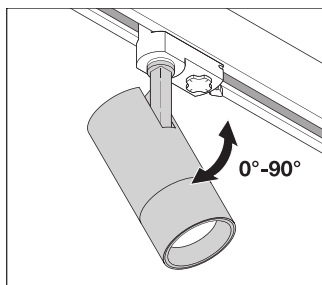
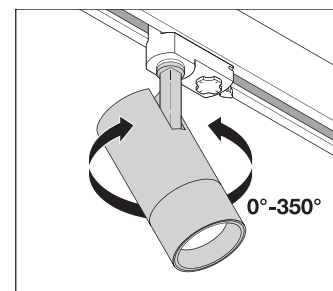
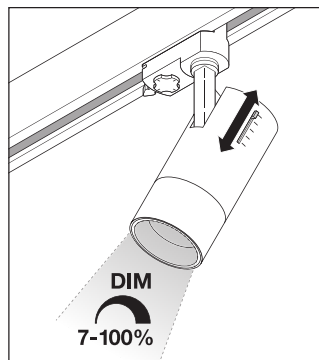
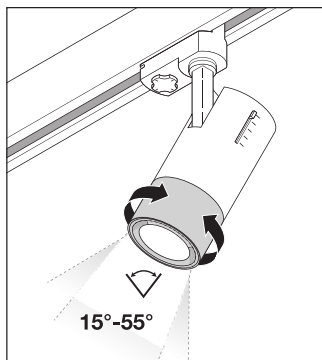

**References / Links**

– For Guarantee see [www.ledvance.com/guarantee](http://www.ledvance.com/guarantee)

---

## DISCLAIMER

Subject to change without notice. Errors and omission excepted. Always make sure to use the most recent release.