







QUICKTRONIC® INTELLIGENT T/E DALI DIM

	QTI-T/E DALI 1X18-57 DIM	QTI-T/E DALI 2X18-42 DIM
10A (B) 	12 x 	8 x 
16A (B) 	19 x 	13 x 
	≤ 30A	≤ 45 A
T_H	225 μs	204 μs

QTI-T/E DALI 1X18-57 DIM

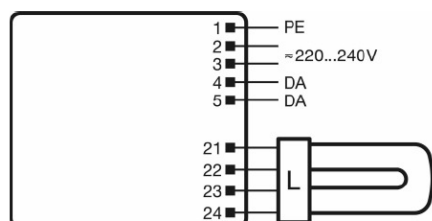

QTI-T/E DALI 2X18-42 DIM

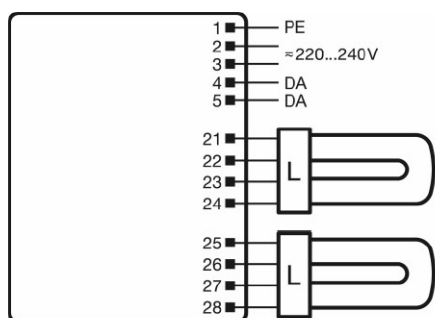

Max. permitted cable length between ECG and lamp: 0,5 m (PIN 21, 22, 23, 24, 25, 26, 27, 28)

(D) Max. Leitungslänge zwischen EVG und Lampe; Leitungslänge max.: 0,5 m (PIN 21, 22, 23, 24, 25, 26, 27, 28)

(RUS) Макс.длина кабеля между прибором и лампой

(KZ) Құрылғы мен шам арасындағы кабельдің максималды ұзындығы.

