

PRODUCT DATASHEET

FL AREA ASYM 48x92 72 W 3000 K BK

FLOODLIGHT AREA | Floodlight with lens based light distribution up to 140 lm/W



Areas of application

- Direct replacement for luminaires using HID lamps
- Outdoor use (IP65)
- Public areas
- Industry
- Sports facilities
- Parking

Product benefits

- Energy savings of up to 90 % compared to halogen lamp floodlights
- Energy savings of up to 45 % compared to luminaires that use conventional discharge lamps
- High light uniformity
- No upper light output ratio (ULOR 0%) when mounted at 0° tilt
- 5 years guarantee

Product features

- High luminous efficacy: up to 140 lm/W
- Asymmetric light distribution for various application areas
- Integrated wide voltage driver, suitable for 100 - 277 V AC
- Angled (30 °) mounting bracket and up to 210 ° tilting
- Type of protection: IP65
- Impact resistance: IK08
- Ambient temperature in operation: -30...+50 °C
- High surge protection: up to 6 kV (L/N-PE), 4 kV (L-N)



- Integrated breather for preventing condensation inside the luminaire
- Pre-installed, flexible 1 m cable (H05RN-F), wrapped 3 x 1.0 mm² single wires

TECHNICAL DATA

Electrical data

Nominal wattage	72.00 W
Nominal voltage	100...277 V
Mains frequency	50...60 Hz
Nominal current	380 mA
Inrush current	13.9 A
Inrush current time T_{h50}	202 μ s
Max. number of luminaires per miniature circuit breaker B16	22
Max. number of luminaires per miniature circuit breaker C10	15
Max. number of luminaires per miniature circuit breaker C16	25
Power factor λ	< 0.90
Total harmonic distortion	< 20 %
Protection class	I
Operating mode	Integrated LED driver

Photometrical data

Luminous flux	9200 lm
Luminous efficacy	129 lm/W
Color temperature	3000 K
Light color (designation)	Warm White
Color rendering index Ra	≥ 80
Standard deviation of color matching	≤ 5 sdc _m
Luminous intensity	-
Low flicker	Yes
Flickering metric (Pst LM)	-
Stroboscope effect metric (SVM)	-
Photobiological safety group acc. to EN62778	RG1
Photobiological safety group acc. to EN62471	RG1
Beam angle	48° x 92 °

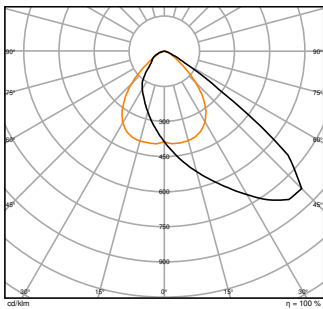

FL AREA 72W 830 ASYM 48X92
BK

Dimensions & Weight

Length	381.00 mm
Width	290.00 mm
Height	59.00 mm
Product weight	3700.00 g
Cable length	1000 mm

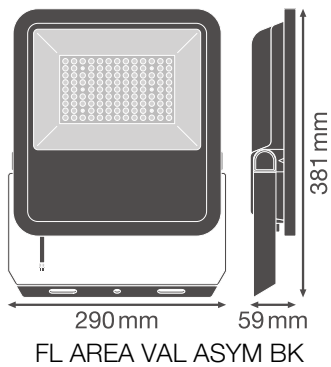

Materials & Colors

Product color	Black
Housing color	Black
Body material	Aluminum
Cover material	Glass
Light emitting surface material	Glass

Glow Wire Test according to IEC 60695-2-12	650 °C
Mercury content	0.0 mg

Application & Mounting

Ambient temperature range	-30...+50 °C
Temperature range at storage	-40...+70 °C
Type of connection	Cable, 3-pole
Type of protection	IP65
Protection class IK (shock resistance)	IK08
Dimmable	No
Mounting type	Surface
Mounting location	Wall / Pole / Floor / Ceiling
Application environment	Outdoor
Adjustable	Yes
With light source	Yes

Lifespan

Lifespan L70/B50 at 25 °C	70000 h ¹⁾
Lifespan L80/B10 at 25 °C	50000 h ¹⁾
Lifespan L80/B50 at 25 °C	50000 h
Lifespan L90/B10 at 25 °C	35000 h
Number of switching cycles	100000

¹⁾ t[h]: L70 / B50 @ 25 °C (Ta), t[h]: L80 / B10 @ 25 °C (Ta), t[h]: L90 / B10 @ 25 °C (Ta)

Control gear

Output current	840 mA
ECG - Output ripple current	< 15 %















Certificates & Standards

Standards	CE / CB / EAC
Luminaire with limited surface temperature, "D sign"	Yes
Ball shot safe	No
Replaceable light source (EPREL)	Not replaceable

Safety advice

– Max. wind load surface 72 W = 0,083 m² / 105 W = 0,102 m² / 145 W = 0,124 m²

DOWNLOAD DATA

Documents and certificates		Document name
	User instruction / safety instructions	UI Floodlight Area Asym MiCh
	Legal information	LSI FL Area
	Legal information	Legal Insert FL AREA
	Legal information	Informationstext 18 Abs 4 ElektroG
	Declarations of conformity	FL AREA ASYM BK
	Declarations of conformity UKCA	FL AREA ASYM
Photometric and lighting design files		Document name
	IES file (IES)	FL AREA 72W 830 ASYM 48X92 BK
	LDT file (Eulumdat)	FL AREA 72W 830 ASYM 48X92 BK
	ULD file (DIALux)	FL AREA 72W 830 ASYM 48X92
	ROLF file (RELUX)	L AREA 72W 830 ASYM
	Light distribution curve type polar	FL AREA 72W 830 ASYM 48X92 BK
CAD/BIM files		Document name
	BIM Revit 3D	Floodlight Area
	CAD STEP 3D	FL AREA 72W
Tender texts		Document name
	Tender documents	FLOODLIGHT AREA 72 W 3000 K BK-EN

LOGISTICAL DATA

Product code	Packaging unit (Pieces/Unit)	Dimensions (length x width x height)	Gross weight	Volume
4058075539730	Shipping box 1	343 mm x 92 mm x 443 mm	4205.00 g	13.98 dm ³

The mentioned product code describes the smallest quantity unit which can be ordered. One shipping unit can contain one or more single products. When placing an order, for the quantity please enter single or multiples of a shipping unit.

References / Links

– For Guarantee see www.ledvance.com/guarantee

DISCLAIMER

Subject to change without notice. Errors and omission excepted. Always make sure to use the most recent release.