



Downlight Compact

- Stijlvolle en compacte LED downlight
- Stevige volledig metalen behuizing
- Geïntegreerde driver voor eenvoudigere installatie
- Geringe hoogte van slechts 35 mm
- IP44 (lichtuitvoerkant)



Specificaties

Artikelcode	Artikelomschrijving	Equivalent (W)	Vermogen (W)	Lumen	Efficiëntie (lm/W)	CCT (K)	Gewicht (kg/st)
Statisch							
540001291600	LEDDownlightCo-E Rd200-24W-840	CFL 2x26W	24	2400	100	4000	0,32

Accessoires



140060652
LEDDownlightRc-HZdim-Adapter-200-225



542098030700
Junction-Box-WH

140060649
LEDDownlightRc-HZdim-Adapter-200-250

Artikel- en verpakkingsinformatie

Artikel			Doosverpakking			
Artikelcode	Artikelomschrijving	EU HS Code	Afmetingen (mm) (LxBxH)	Brutogewicht (kg)	EAN	st/doos
540001291600	LEDDownlightCo-E Rd200-24W-840	94051190	243x52x245	0,46	6941408895734	1
140060649	LEDDownlightRc-HZdim-Adapter-200-250	94059900	275x275x0.8	0,31	6956321894153	1
140060652	LEDDownlightRc-HZdim-Adapter-200-225	94059900	250x250x0.8	0,23	6956321894184	1
542098030700	Junction-Box-WH	85369010	43x103.4x26	0,06	6941408868684	1

5 JAAR GARANTIE



Technische specificaties	
Levensduur (L70)	50.000 u
Levensduur (L80)	30.000 u
Aan-/Uit-cycli	100.000
Kleurconsistentie (SDCM)	3
Dimbaarheid	On-Off
Bundelhoek	100°
Afwerking	Wit RAL9003
CRI	≥ 80
IP voorzijde	IP44
IP-klasse achterzijde	IP20
Slagvastheid	IK02
Beschermingsklasse	II
Risicogroep (EN 62471)	RG0
Voorschakelapparaat inbegrepen	Ja
Gloeidraadtest	650°C
Verplaatsingsfactor	≥ 0.9

Elektrische aansluiting	
Frequentie	50/60 Hz
Nom. spanning	220-240 V
DC ingangsspanning	Nee
230V Kabellengte	0.3 m

Materiaal eigenschappen	
Materiaal behuizing	Aluminium
Materiaal optiek	Polycarbonaat

Toepassingscondities	
Bedrijfstemperatuur	-10-+45°C
Gebruikstemperatuur	+25°C
Opslagtemperatuur	-25-+45°C

Maatschets (mm)

LEDDownlightCo-E Rd200

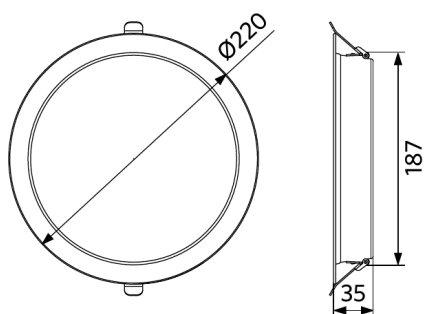

Fotometrische gegevens

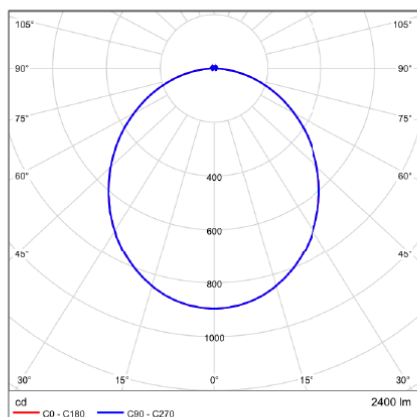

Tekening inbouwmaat (mm)

LEDDownlightCo-E Rd200
Ø200

