

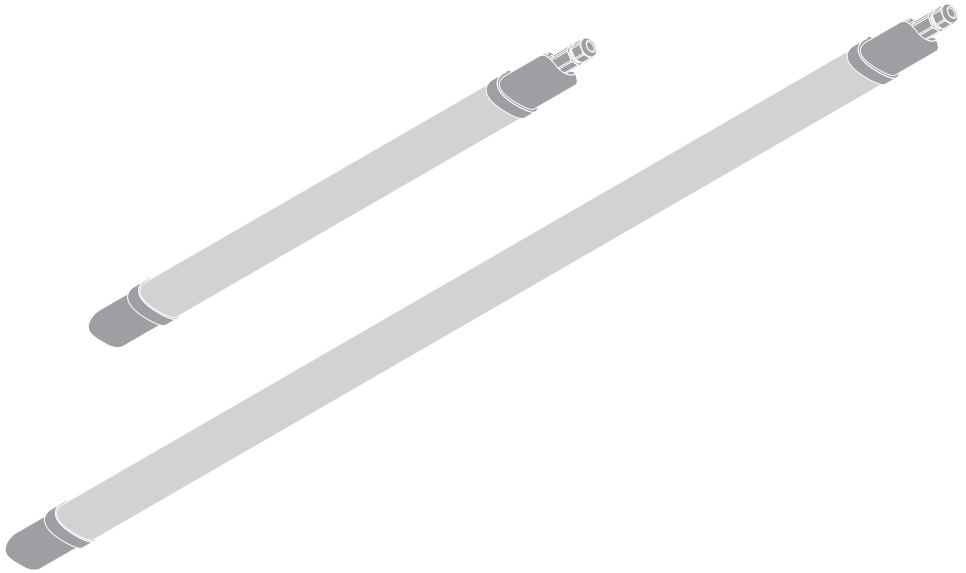



DAMP PROOF ESSENTIAL I SLIM



	EAN	l x w x h [mm]	W	VAC	Hz	light source lm	output lm	mA
DAMP PROOF ESSENTIAL I SLIM 60CM840	4058075762619	660x53x35	9	220-240V	50/60Hz	1050	900	75mA
DAMP PROOF ESSENTIAL I SLIM120CM840	4058075762633	1260x53x35	18	220-240V	50/60Hz	2100	1800	135mA

	EAN		K	IP		R _a	°(°C)	DF	
DAMP PROOF ESSENTIAL I SLIM 60CM840	4058075762619	100000	4000	65	120	>80	-20...+35	> 0.5	175g
DAMP PROOF ESSENTIAL I SLIM120CM840	4058075762633	100000	4000	65	120	>80	-20...+35	> 0.5	300g

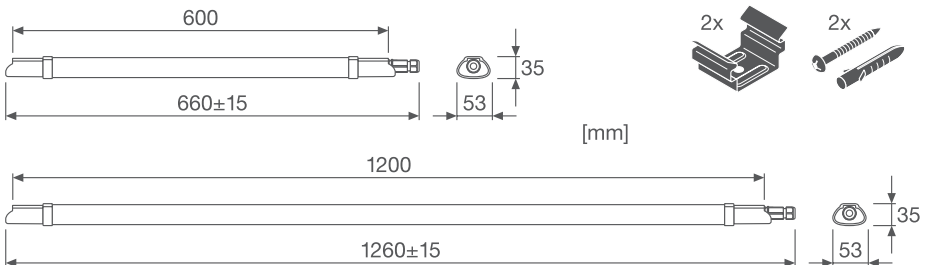

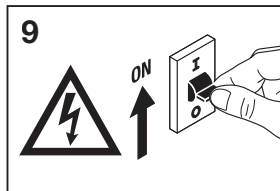
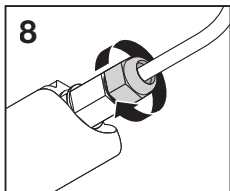
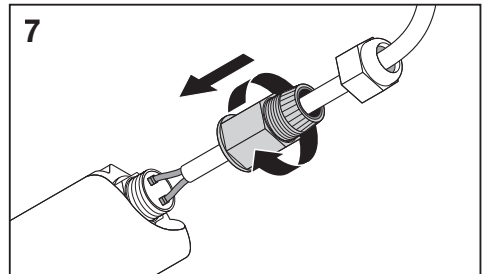
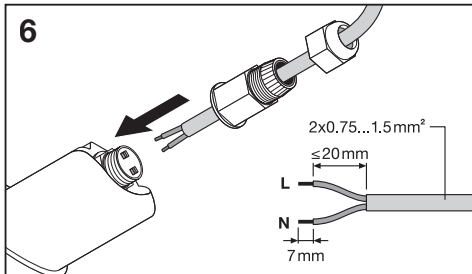
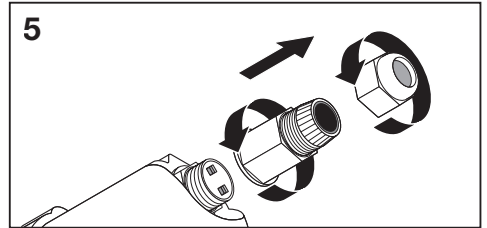
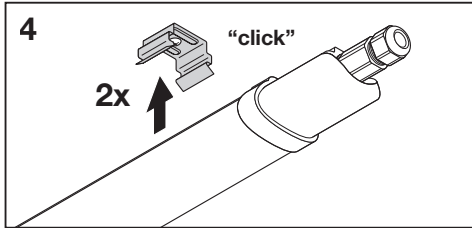
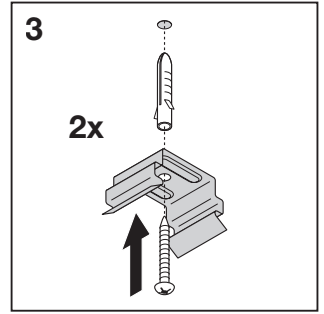
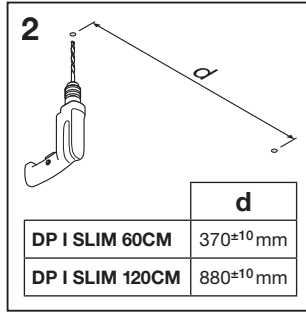
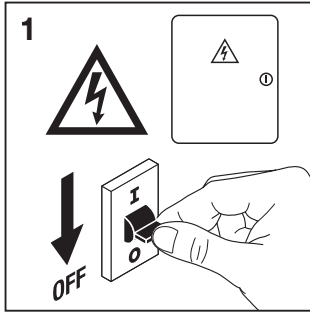

ENERGY EFFICIENCY CLASS: E

**DAMP PROOF
ESSENTIAL I
SLIM 60CM840**

**DAMP PROOF
ESSENTIAL I
SLIM 120CM840**

EAN 4058075762619

EAN 4058075762633

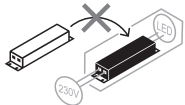

Points de collecte sur www.quefairedemesdechets.fr



LEDVANCE GmbH
Steinerne Furt 62
86167 Augsburg, Germany
www.ledvance.com

C10449057
G11139680

06.05.22

© LEDVANCE Ltd, Aquila House
Delta Crescent, Westbrook, Warrington
WA5 7NR, United Kingdom