

FLAT POLYMERO KREIS SLIM

312085.002.3 | Ceiling and wall luminaires



Ceiling and wall luminaires
4051859155522
D 360, H 65

Ceiling mounting, Wall (surface)
white

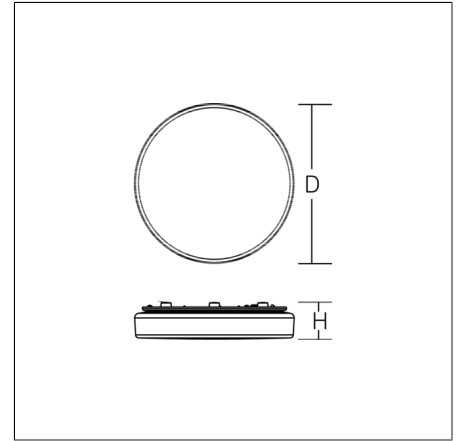

Flat decorative round LED surface-mounted luminaire. Base: metal, powder-coated. Diffuser made of non-yellowing plastic (PMMA), opal. Diffuser fastening: patented push system. Suitable for Ceiling mounting, Wall (surface).

Product specifications

Diameter D	360 mm
Height H	65 mm
Weight	1.43 kg
Light source	LED
Colour temperature	4000 K
Rated luminous flux	2000 lm
System power	19 W
System efficiency	105 lm/W
Glare evaluation UGR (4H 8H)	20,6
Beam angle	down 122° up 180°
Rated life	50000 h (L80/B10)
Colour rendering index (CRI)	83
Colour tolerance	3
Photobiological safety according to EN 62471	Risk group 1
Driver	Converter, dimmable
Control	Phase cut-off/cut-on
Voltage	220 - 240 V / 50 - 60 Hz
Luminaires on B10A fuse	84
Luminaires on B16A fuse	135
Luminaires on C10A fuse	84
Luminaires on C16A fuse	135
Inrush current / Inrush current duration	0.22 A / 200 µs
CIE Flux Code / CEN Flux Code	42 73 92 84 100
Type of protection	IP 40
Protection class	I
Filament test	650°C - 30 seconds
Impact resistance	IK03
Ambient temperature	-20 °C ... + 35 °C
Conformity mark	CE

Spareparts



08-312085.002
Replacement diffuser