

High Power LED Floodlight

High Power LED Floodlight with asymmetric light distribution, FLEX technology, IP66 for outdoor applications. Luminaire input power: 80 W, Lifetime: 50.000h L80, Total luminous flux: 10000 lm. Luminaire efficacy: 125 lm/W. Colour rendering Ra > 80, colour temperature 4000 K, Chromaticity tolerance (initial MacAdam): 5, Impact strength: IK08. Climate membrane for automatic climate regulation. Surge protection 10kV. Pre-wired with mains cable (1m) including connector for easy and tool-free wiring. Integrated adjustable photocell. Corrosion class C4. Product is not suitable for chlorine environments. Body: die-cast aluminium (<0,1% copper), anthracite grey (RAL 7016), Bracket: steel, anthracite grey. Cover: Tempered glass. Input power adjustable on site by 3 step (FLEX1: 10000 lm (80W), FLEX2: 9000 lm (70W), FLEX3 - 7500 lm (55W)). For flex data on other colour temperatures please visit website. Dimensions: 330 x 359 x 56 mm, weight: 3.2 kg.

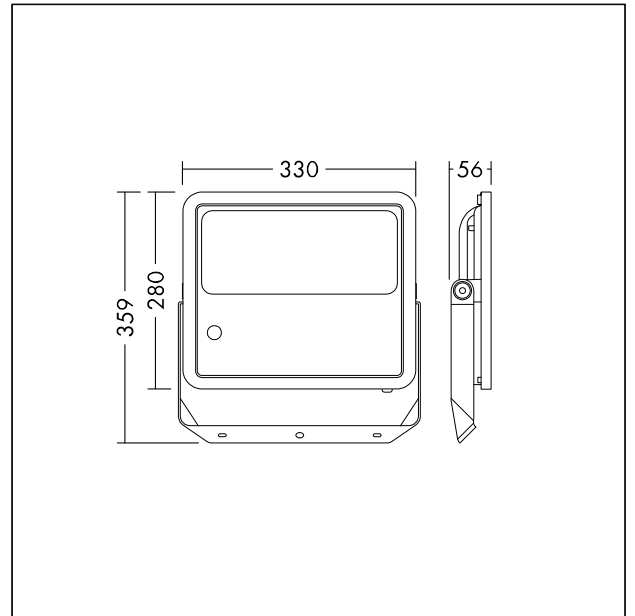

TE_LEOFLEX_F_80_front.jpg



TE_LEOFLEX_M_80.wmf

Light Distribution

STD - standard

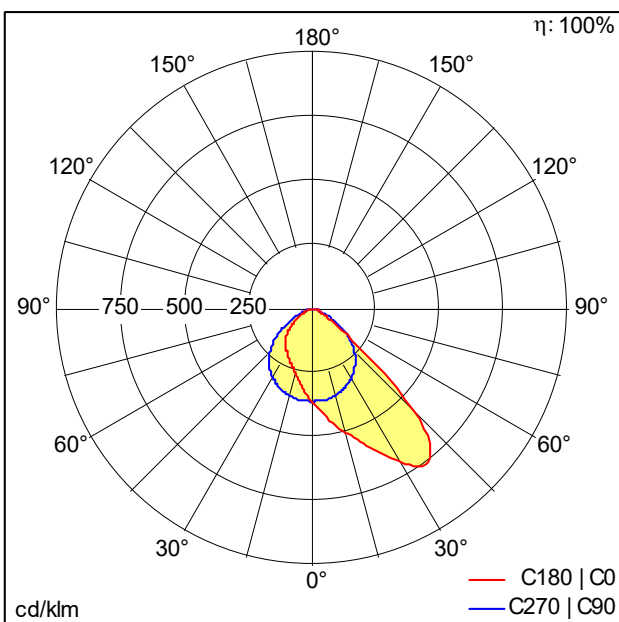

TE_LEO_FLEX_80W_840_FLEX1.idt

- Light Source: LED
- Luminaire luminous flux*: 10010 lm
- Luminaire efficacy*: 125 lm/W
- Colour Rendering Index min.: 80
- Correlated colour temperature*: 4000 Kelvin
- Chromaticity tolerance (initial MacAdam): 5
- Rated median useful life*:
L80 50000 h at 25 °C
- Ballast: 1x LED_Con
- Luminaire input power*: 80 W Power factor = 0.91
- Dimming: Fixed output
- Maintenance category CIE 97: E - Dust-proof IP5X
- Total harmonic distortion (THD): 15.00 %

This product contains a light source of energy efficiency class D.

All values marked with an * are rated values. Connected electrical load and luminous flux are subject to an initial tolerance of +/- 10%, the most similar colour temperature is subject to an initial tolerance of +/- 150K. Unless stated otherwise, the values apply to an ambient temperature of 25°C.