

PRODUCT DATASHEET

PL PROT 625 P 36W 840 U19 DALIVR

PANEL PROTECT 625 UGR<19 DALI | Square recessed panel luminaires with IP54 protection, DALI-2 IoT technology and low glare, 625 x 625 mm

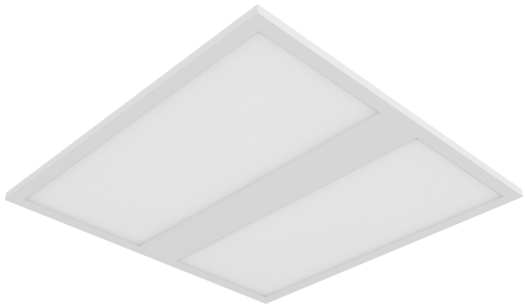

Areas of application

- Direct replacement for luminaires with fluorescent lamps
- Suitable for recessed ceiling systems with grid size of 625 x 625 mm
- Hospitals
- Laboratories
- Kitchens, canteens, workspaces

Product benefits

- Suitable for use in applications where a higher IP and IK protection is needed
- Highly versatile due to selectable power steps (Power Select - PS) on the driver and up to 5040 lm
- Tool-free electrical connection due to push button connector
- Through-wiring possible with included connector box
- Energy savings thanks to high system efficacy: up to 140 lm/W
- High color consistency with SDCM 3
- Extended services such as energy monitoring and remote maintenance possible with DALI versions
- Good glare reduction ($UGR \leq 19$)
- Extended heat resistance of the diffuser with up to 850° C
- Suitable for battery emergency installations acc. to EN 60598-2-22
- Decentral emergency lighting possible with separately available LEDVANCE Emergency Conversion Box
- 5 years guarantee

Product features



- Type of protection: IP54 (frontside), IP20 (backside)
- Steel housing with notch in the backside for the driver to allow maximum height of 34 mm
- Polycarbonate (PC) diffuser
- 5-pole terminal block, cable cross section up to 5 x 2.5 mm²
- Lifetime (L90/B10): 50,000 h (at 25° C)
- Panel can be customized with optical sensors on individual request

TECHNICAL DATA

Electrical data

Nominal wattage	36.00 W ¹⁾
Nominal voltage	220...240 V
Mains frequency	0/50/60 Hz
Nominal current	165.000 mA
Inrush current	0.2 A
Inrush current time T _{h50}	450 µs
Max. number of luminaires per miniature circuit breaker B16	23
Max. number of luminaires per miniature circuit breaker C10	16
Max. number of luminaires per miniature circuit breaker C16	26
Power factor λ	> 0.90
Total harmonic distortion	< 20 %
Protection class	II
Operating mode	External LED driver

¹⁾ The Panel Protect family is fulfilling the technical minimum requirements according to the German BEG subsidy program for energy efficient luminaires

Photometrical data

Luminous flux	5040 lm ¹⁾
Luminous efficacy	140 lm/W ¹⁾
Color temperature	4000 K
Light color (designation)	Cool White
Color rendering index Ra	> 80
Standard deviation of color matching	3 sdc _m
Low flicker	Yes
Flickering metric (Pst LM)	<1
Stroboscope effect metric (SVM)	< 0.4
Photobiological safety group acc. to EN62778	RG0
Photobiological safety group acc. to EN62471	RG0
Beam angle	90 °
UGR	< 19

¹⁾ The Panel Protect family is fulfilling the technical minimum requirements according to the German BEG subsidy program for energy efficient luminaires

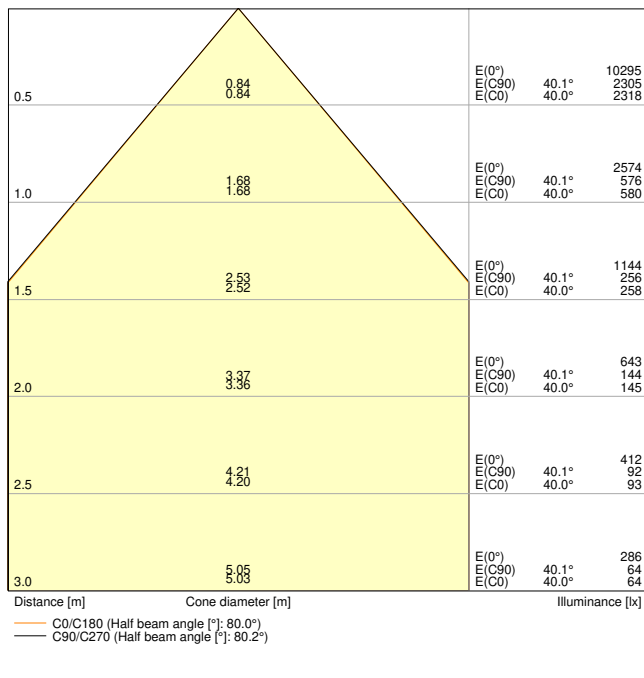

LDC typ cone

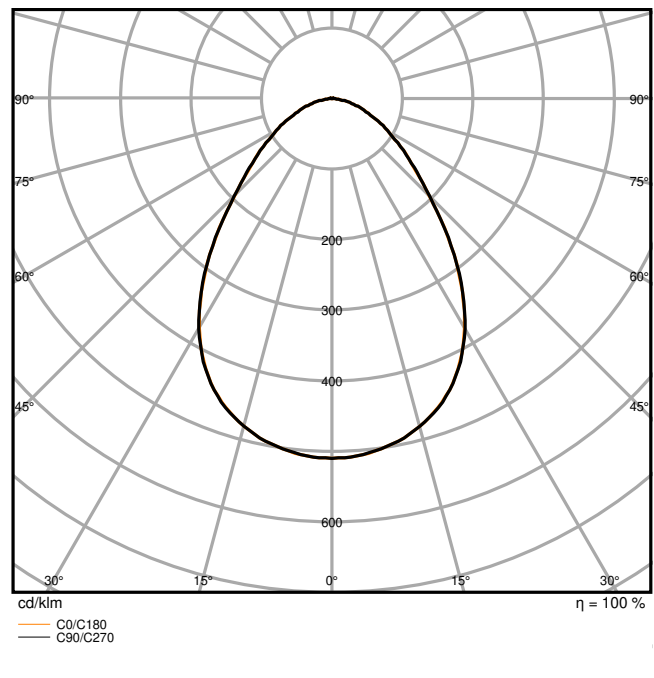

LDC typ polar

Dimensions & Weight

Length	620.00 mm
Width	620.00 mm
Height	34.00 mm
Product weight	2530.00 g

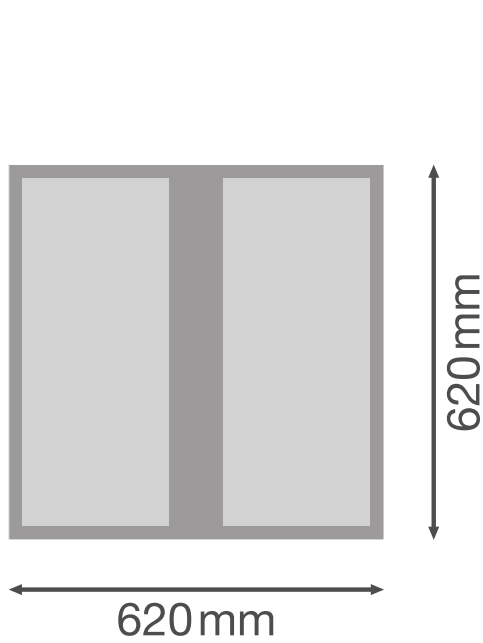

Product line drawing with numbers

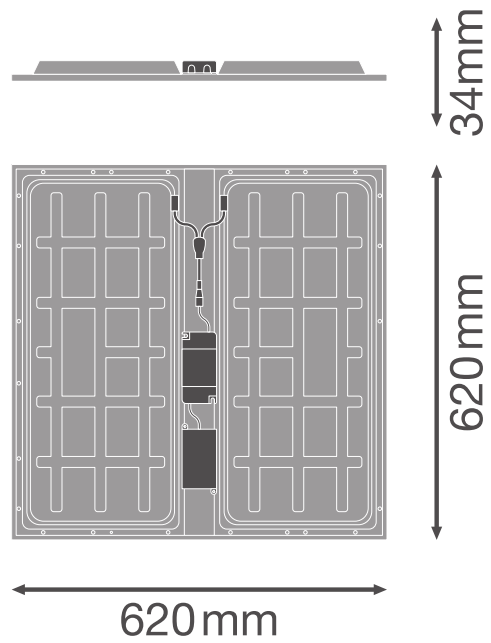

Product line drawing with numbers

Materials & Colors

Product color	White
Housing color	White
Body material	Steel
Cover material	Polycarbonate (PC)
Light emitting surface material	Polycarbonate (PC)
Glow Wire Test according to IEC 60695-2-12	850 °C
Mercury content	0.0 mg

Application & Mounting

Ambient temperature range	-10...+50 °C
Temperature range at storage	-20...+70 °C
Type of connection	Screwless terminal, 5-Pole (L, N, PE, DA+, DA-)
Type of protection	IP54/IP20
Protection class IK (shock resistance)	IK06
Dimmable	Yes
Type of dimming	DALI2

Mounting type	Recessed/Suspended/Surface
Mounting location	Ceiling
Application environment	Indoor
Mounting length	600 mm
Mounting width	600 mm
Mounting depth	50,0 mm
Adjustable	No
LED module replaceable	Not replaceable
With light source	Yes

Lifespan

Lifespan L70/B50 at 25 °C	100000 h ¹⁾
Lifespan L80/B10 at 25 °C	70000 h ¹⁾
Lifespan L90/B10 at 25 °C	50000 h
Number of switching cycles	100000

¹⁾ t[h]: L70 / B50 @ 25 °C (Ta), t[h]: L80 / B10 @ 25 °C (Ta), t[h]: L90 / B10 @ 25 °C (Ta)

Control gear

Output current	800 mA
ECG - Output ripple current	< 5 %
ECG - Length	145 mm
ECG - Width	75,0 mm
ECG - Height	25,0 mm
Recommended control gear	OSRAM OTi_DALI_50/220-240/1A4 NFC / TRIDONIC LCA 45W 500-1400mA one4all SC PRE

Emergency lighting

Wattage in emergency operation mode	6.5 W
Luminous flux in emergency operation mode	720 lm

Certificates & Standards

Standards	CE / CB / ENEC / UKCA / EAC / EL
Luminaire with limited surface temperature, "D sign"	No
Ball shot safe	No















Additional product data

Product remark	Available from September 2023
----------------	-------------------------------

EQUIPMENT / ACCESSORIES

- Accessories for several mounting options available
- Connector box with 5-pole terminal pre-installed
- Security brackets preinstalled
- External control gear included
- Suitable for use with separate Emergency Conversion Box
- Special mounting frame with an overall height of only 50 mm available separately

DOWNLOAD DATA

Documents and certificates	
	User instruction
	Addon Technical Information
	Packaging insert
	Declarations Of Conformity CE
	Declarations Of Conformity UKCA
Photometric and lighting design files	
	IES file (IES)
	LDT file (Eulumdat)
	ULD file (DIALux)
	ROLF file (RELUX)
	UGR file (UGR table)
	LDC typ cone
	LDC typ polar
CAD/BIM files	
	BIM_Revit_3D
	CAD_STEP_3D

Tender texts



Tender documents

LOGISTICAL DATA

Product code	Packaging unit (Pieces/Unit)	Dimensions (length x width x height)	Gross weight	Volume
4099854083501	Folding box 1	41 mm x 627 mm x 627 mm	2958.00 g	16.12 dm ³
4099854083518	Shipping box 5	645 mm x 229 mm x 656 mm	15888.00 g	96.89 dm ³

The mentioned product code describes the smallest quantity unit which can be ordered. One shipping unit can contain one or more single products. When placing an order, for the quantity please enter single or multiples of a shipping unit.

ADDITIONAL CATALOG INFORMATION

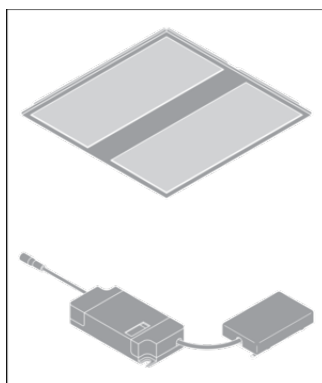
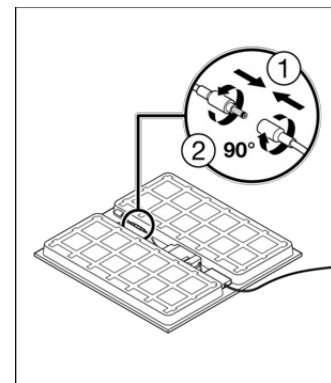
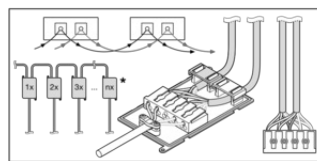
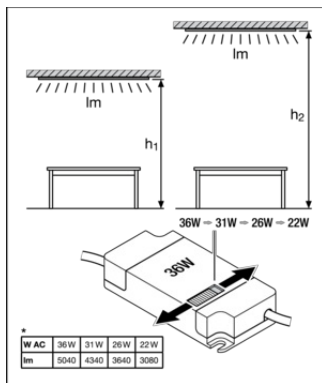

References / Links

- For Guarantee see www.ledvance.com/guarantee

DISCLAIMER

Subject to change without notice. Errors and omission excepted. Always make sure to use the most recent release.