

PRODUCT DATASHEET

PANEL VAL DALI 625 UGR < 19 36 W 4000 K WT DALI

PANEL VALUE 625 UGR < 19 | Square recessed panel luminaires, low glare, 625 x 625 mm

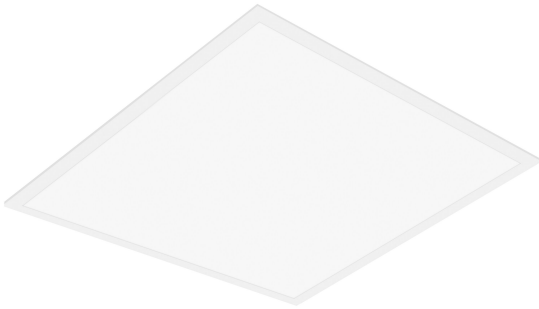

Areas of application

- Direct replacement for luminaires with fluorescent lamps
- Offices, conference rooms
- Reception areas, foyers, corridors, elevators
- Suitable for recessed ceiling systems with grid size of 625 x 625 mm

Product benefits

- Value for money luminaire
- Good glare reduction (UGR < 19)
- Low flicker light thanks to special electronic control gear
- Energy savings thanks to system efficacy of up to 100 lm/W
- External driver for extended flexibility and easy installation
- Emergency lighting possible with LEDVANCE Emergency Conversion Box
- Versions with DALI ECG available

Product features

- Lifetime (L70/B50): up to 50,000 h (at 25 °C)
- Extruded aluminum frame
- Polystyrene diffuser



TECHNICAL DATA

Electrical data

Nominal wattage	36.00 W
Nominal voltage	220...240 V
Mains frequency	0/50/60 Hz
Nominal current	178.000 mA
Inrush current	10.4 A
Inrush current time T_{h50}	200 μ s
Max. no. of lum. on circuit break. B16 A	23
Max. no. of lum. on circuit break. C10 A	23
Max. no. of lum. on circuit break. C16 A	38
Power factor λ	> 0.90
Total harmonic distortion	< 15 %
Protection class	II
Operating mode	External LED driver

Photometrical data

Luminous flux	3600 lm
Luminous efficacy	100 lm/W
Color temperature	4000 K
Light color (designation)	Cool White
Color rendering index Ra	> 80
Standard deviation of color matching	5 sdc _m
Luminous intensity	-
Low flicker	Yes
Flickering metric (Pst LM)	-
Stroboscope effect metric (SVM)	-
Photobiological safety group acc. to EN62778	RG0
Beam angle	90 °
UGR	< 19

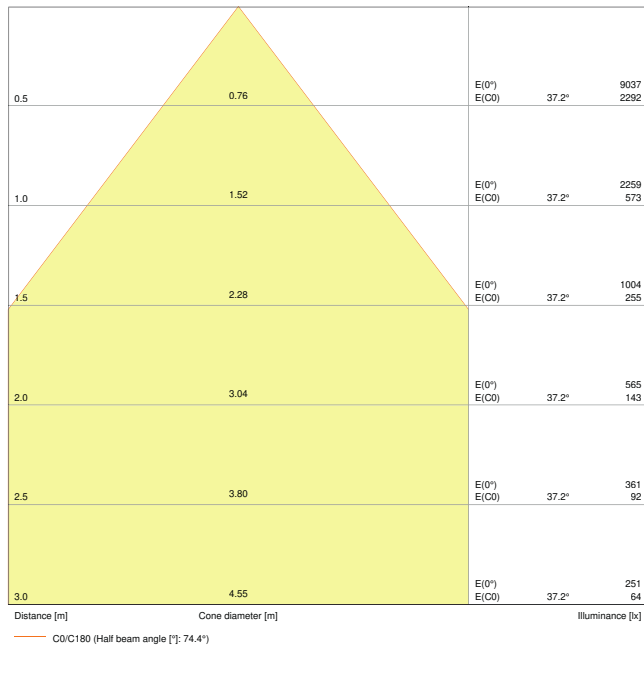

LDC typ cone

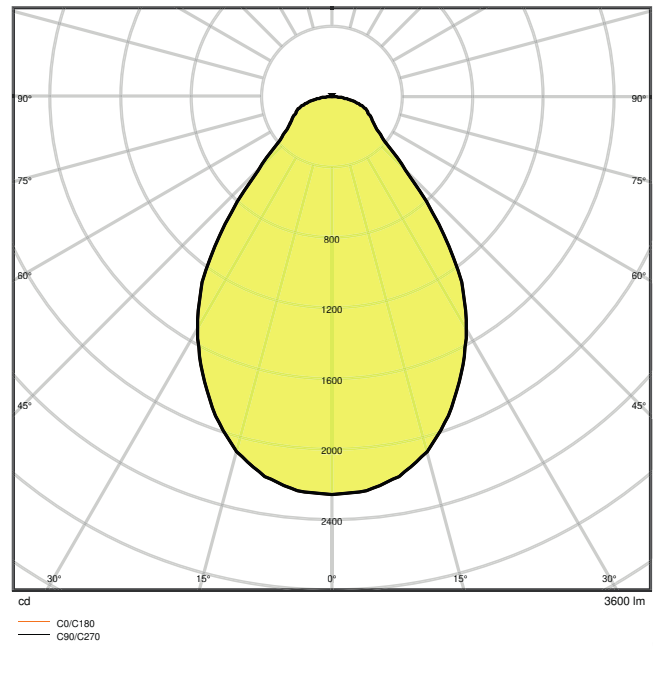

LDC typ polar

Dimensions & Weight

Length	620.00 mm
Width	620.00 mm
Height	35.00 mm
Product weight	1900.00 g

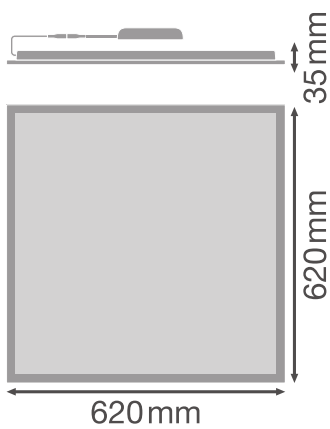

Materials & Colors

Product color	White
Housing color	White
Body material	Aluminum
Cover material	Polystyrene (PS)
Light emitting surface material	Polystyrene
Glow Wire Test according to IEC 60695-2-12	650 °C
Mercury content	0.0 mg

Application & Mounting

Ambient temperature range	-10...+45 °C
Type of connection	Screwless terminal
Type of protection	IP40
Protection class IK (shock resistance)	IK02
Dimmable	Yes
Type of dimming	DALI
Mounting type	Recessed/Suspended/Surface
Mounting location	Ceiling / Wall
Application environment	Indoor
Mounting length	580 mm
Mounting width	580 mm
Mounting depth	50,0 mm
LED module replaceable	Not replaceable

Lifespan

Lifespan L70/B50 at 25 °C	50000 h
Lifespan L80/B10 at 25 °C	50000 h
Lifespan L90/B10 at 25 °C	30000 h
Number of switching cycles	25000











Certificates & Standards

Standards	CE / CB / EAC
Luminaire with limited surface temperature, "D sign"	No
Ball shot safe	No

EQUIPMENT / ACCESSORIES

- Accessories for several mounting options available
- External control gear included
- Security brackets included

DOWNLOAD DATA

DOWNLOAD DATA	
	User instruction
	Addon Technical Information
	Addon Technical Information
	Tender documents
	Declarations Of Conformity CE
	IES file (IES)
	LDT file (Eulumdat)
	R3D file (Relux 3D Model)
	M3D file (3D Model)
	ULD file (DIALux)
	UGR file (UGR table)

LOGISTICAL DATA

Product code	Packaging unit (Pieces/Unit)	Dimensions (length x width x height)	Gross weight	Volume
4058075392601	Folding box 1	672 mm x 40 mm x 627 mm	2392.00 g	16.85 dm ³
4058075392618	Shipping box 4	655 mm x 170 mm x 645 mm	10815.00 g	71.82 dm ³

The mentioned product code describes the smallest quantity unit which can be ordered. One shipping unit can contain one or more single products. When placing an order, for the quantity please enter single or multiples of a shipping unit.

ADDITIONAL CATALOG INFORMATION

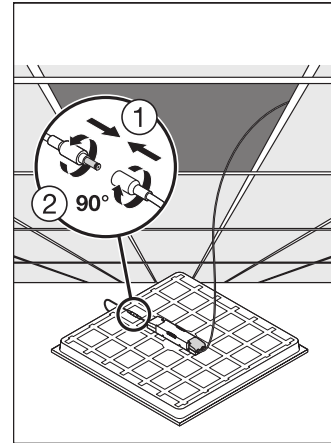
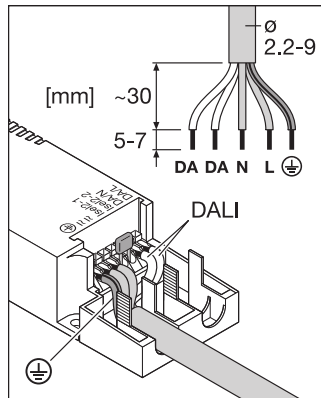
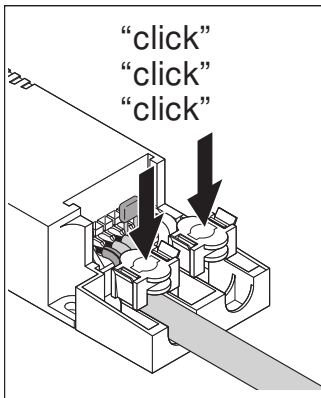

DISCLAIMER

Subject to change without notice. Errors and omission excepted. Always make sure to use the most recent release.