

Wall-/ceiling luminaire

Circular IP66 bulkhead with switchable colour temperature: choose between warm white (3000K) and neutral white (4000K) to suit application use. High colour rendering and uniform light surface with no shadowing. Direct replacement for 2x 26W CFL. More than 60% energy savings compared with luminaires with CFL lamps. Frosted diffuser ensures a homogeneous light effect and visual comfort. Piano key terminal for wires up to 2.5mm². Integrated microwave presence sensor maximizing the energy saving potential. Shock resistance degree: IK10. Body: white (RAL 9010), Polycarbonate (UV stabilised). Diffuser: opal, Polycarbonate (UV stabilised). Weight: 0,8 kg

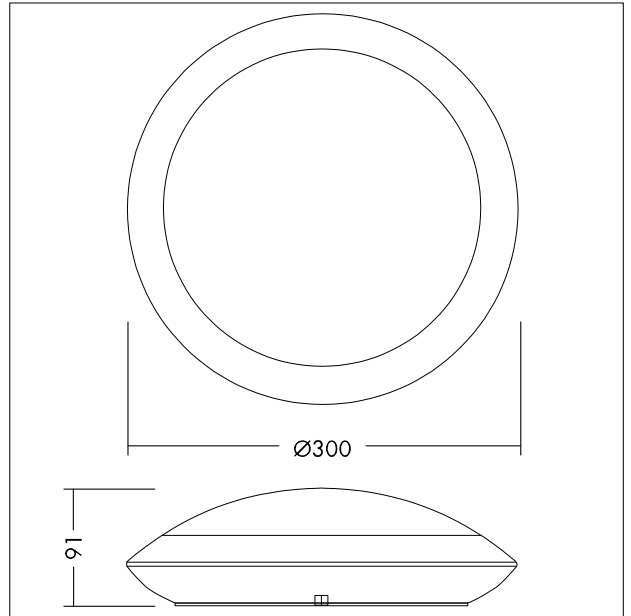

TE_TOM_F_2nd_300_WHM.jpg



TE_TOML_M_LD2.wmf

Light Distribution

STD - standard

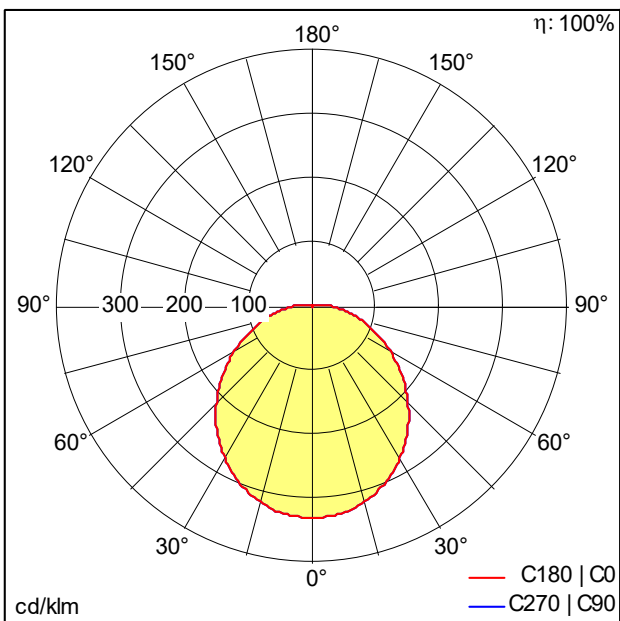

TE_TOM_VARIO_LED_300_2000_840_MWS_WH.Idt

- Light Source: LED
- Luminaire luminous flux*: 2002 lm
- Luminaire efficacy*: 100 lm/W
- Colour Rendering Index min.: 80
- Correlated colour temperature*: 3000-4000 Kelvin
- Chromaticity tolerance (initial MacAdam): 6
- Rated median useful life*: L70 50000 h at 25 °C
- Ballast: 1x LED_Con
- Luminaire input power*: 20 W Power factor = 0.9
- Dimming: Fixed output
- Maintenance category CIE 97: E - Dust-proof IP5X
- Total harmonic distortion (THD): 30.00 %

This product contains a light source of energy efficiency class E.

All values marked with an * are rated values. Connected electrical load and luminous flux are subject to an initial tolerance of +/- 10%, the most similar colour temperature is subject to an initial tolerance of +/- 150K. Unless stated otherwise, the values apply to an ambient temperature of 25°C.