

#### Driver LC 100W 24V IP67 L EXC UNV

Constant voltage excite series (universal voltage)

#### Product description

- Constant voltage LED Driver
- Universal input voltage range
- Max. output power 100 W
- Nominal life-time up to 50,000 h
- 5-year guarantee

#### Housing properties

- Casing: aluminum, grey
- Type of protection IP67
- Dry, damp and wet location
- Potted version: higher protection against corrosion

#### Functions

- Overtemperature protection
- Overload protection
- Short-circuit protection
- No-load protection



**Standards**, page 3

**Wiring diagrams and installation examples**, page 3

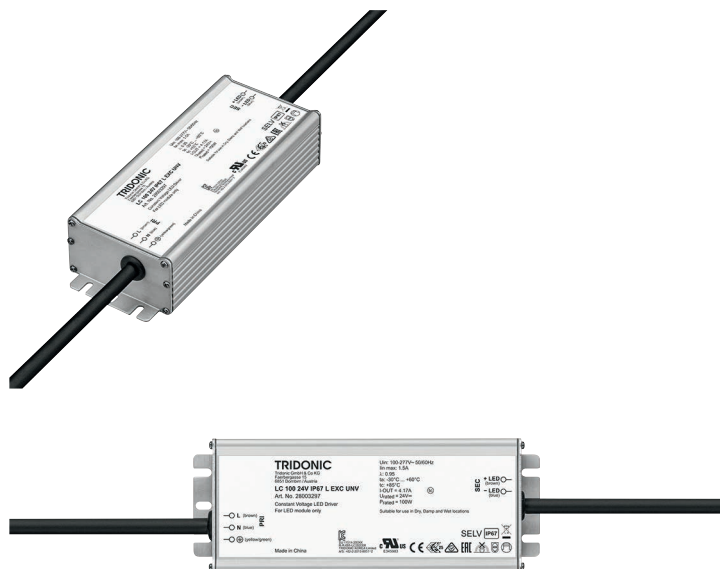

SELV IP67 

### Driver LC 100W 24V IP67 L EXC UNV

Constant voltage excite series (universal voltage)

#### Technical data

Rated supply voltage	100 – 277 V
AC voltage range	90 – 305 V
Mains frequency	50 / 60 Hz
Rated current (at 120 V, 60 Hz)	1.5 A
Rated current (at 230 V, 50 Hz)	1.5 A
Rated current (at 277 V, 60 Hz)	1.5 A
Leakage current (at 120 V, 60 Hz, full load)	< 750 µA
Leakage current (at 230 V, 50 Hz, full load)	< 750 µA
Leakage current (at 277 V, 60 Hz, full load)	< 750 µA
Efficiency (at 120 V, 60 Hz)	> 88 %
Efficiency (at 230 V, 50 Hz)	> 90 %
Efficiency (at 277 V, 60 Hz)	> 90 %
λ (at 120 V, 60 Hz)	0.98
λ (at 230 V, 50 Hz)	0.95
λ (at 277 V, 60 Hz)	0.9C
Output voltage tolerance	22.8 – 25.2 V
Max. output power	100 W
Output LF current ripple (< 120 Hz)	± 5 %
Starting time (output)	≤ 1 s
Hold on time at power failure (output)	≤ 1 ms
Mains burst capability	1 kV
Mains surge capability (between L – N)	5 kV
Mains surge capability (between L/N – PE)	10 kV
Surge voltage at output side (against PE)	< 500 V
Max. casing temperature tc	85 °C
Ambient temperature ta (at life-time 50,000 h)	45 °C
Storage temperature	-40 ... +85 °C
Type of protection	IP67
Life-time	up to 50,000 h
Guarantee	5 years
Dimensions LxWxH	178 x 68 x 39 mm
Hole spacing D	163 mm

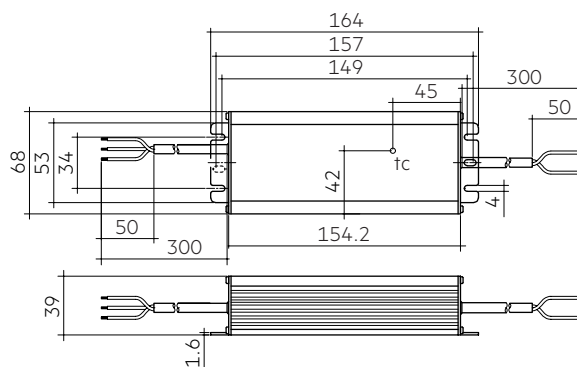

Dimensions in mm

#### Ordering data

Type	Article number	Packaging carton	Packaging pallet	Weight per pc.
LC 100W 24V IP67 L EXC UNV	28003297	10 pc(s).	240 pc(s).	0.825 kg

#### Specific technical data

Type	Load	Forward voltage	Output current	Max. output power	Typ. power consumption (at 120 V, 60 Hz)	Typ. current consumption (at 120 V, 60 Hz)	Typ. power consumption (at 230 V, 50 Hz)	Typ. current consumption (at 230 V, 50 Hz)	Typ. power consumption (at 277 V, 60 Hz)	Typ. current consumption (at 277 V, 60 Hz)	Ambient temperature ta max.
LC 100W 24V IP67 L EXC UNV	10 %	24.5 V	417 mA	10.2 W	14.2 W	133 mA	14.2 W	102 mA	14.1 W	122 mA	-40 ... 60 °C
	20 %	24.5 V	834 mA	20.5 W	24.9 W	217 mA	25.4 W	150 mA	25.1 W	142 mA	-40 ... 60 °C
	30 %	24.5 V	1,251 mA	30.7 W	35.7 W	304 mA	35.9 W	200 mA	36.0 W	171 mA	-40 ... 60 °C
	40 %	24.5 V	1,667 mA	40.9 W	46.7 W	395 mA	46.6 W	247 mA	46.6 W	227 mA	-40 ... 60 °C
	50 %	24.5 V	2,084 mA	51.1 W	57.7 W	486 mA	57.2 W	289 mA	57.2 W	289 mA	-40 ... 60 °C
	60 %	24.5 V	2,501 mA	61.3 W	68.8 W	577 mA	67.8 W	322 mA	67.9 W	325 mA	-40 ... 60 °C
	70 %	24.5 V	2,918 mA	71.5 W	79.9 W	670 mA	78.5 W	356 mA	78.5 W	353 mA	-40 ... 60 °C
	80 %	24.5 V	3,335 mA	81.7 W	91.2 W	764 mA	89.3 W	401 mA	89.2 W	379 mA	-40 ... 60 °C
	90 %	24.4 V	3,752 mA	91.9 W	102.1 W	857 mA	99.9 W	447 mA	99.7 W	403 mA	-40 ... 60 °C
	100 %	24.4 V	4,169 mA	101.9 W	114.2 W	954 mA	111.0 W	494 mA	110.7 W	431 mA	-40 ... 60 °C

## 1. Standards

EN 55015  
 EN 61000-3-2  
 EN 61000-3-3  
 EN 61347-1  
 EN 61347-2-13  
 EN 62384  
 EN 60598-1  
 UL8750

## 2. Thermal details and life-time

### 2.1 Expected life-time

#### 120 V, 60 Hz

Type	Output voltage	ta	55 °C	60 °C	65 °C	70 °C
LC 100W 24V IP67 L EXC UNV	24 V	tc	85 °C	90 °C	95 °C	100 °C
		Life-time	> 15,000 h	> 10,000 h	> 5,000 h	> 5,000 h

#### 230 V, 50 Hz

Type	Output voltage	ta	55 °C	60 °C	65 °C	70 °C
LC 100W 24V IP67 L EXC UNV	24 V	tc	75 °C	80 °C	85 °C	90 °C
		Life-time	> 55,000 h	> 35,000 h	> 25,000 h	> 15,000 h

#### 277 V, 60 Hz

Type	Output voltage	ta	55 °C	60 °C	65 °C	70 °C
LC 100W 24V IP67 L EXC UNV	24 V	tc	75 °C	80 °C	85 °C	90 °C
		Life-time	> 55,000 h	> 35,000 h	> 25,000 h	> 15,000 h

## 3. Installation / Wiring

### 3.1 Wiring diagram

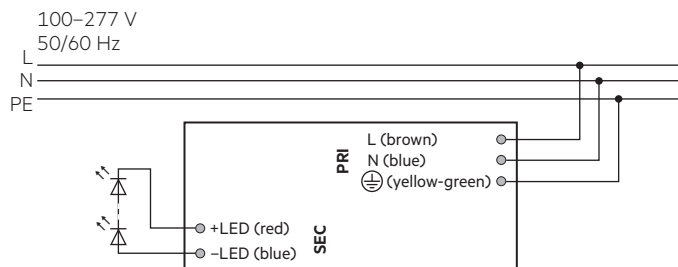

### 3.2 Connection

Primary cable			Secondary cable	
L	N	PE	+	-
brown	blue	yellow-green	brown	blue

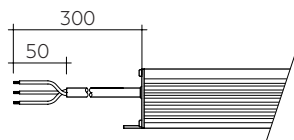

#### PRI:

3x1.0 mm<sup>2</sup>

#### SEC:

2x1.0 mm<sup>2</sup>

### 3.3 Wiring guidelines

- All connections must be kept as short as possible to ensure good EMI behaviour.
- Mains leads should be kept apart from LED Driver and other leads (ideally 5 – 10 cm distance)
- Max. length of output wires is 2 m.
- Incorrect wiring can damage LED modules.
- To avoid the damage of the Driver, the wiring must be protected against short circuits to earth (sharp edged metal parts, metal cable clips, louver, etc.).

### 3.4 Hot plug-in

Hot plug-in or secondary switching of LEDs is supported.

**3.5 Earth connection**

The earth connection is conducted as protection earth (PE). The LED Driver can be earthed via metal housing. If the LED Driver will be earthed, protection earth (PE) has to be used. There is no earth connection required for the functionality of the LED Driver. Earth connection is recommended to improve following behaviour:

- Electromagnetic interferences (EMI)
- LED glowing at standby
- Transmission of mains transients to the LED output

In general it is recommended to earth the LED Driver if the LED module is mounted on earthed luminaire parts respectively heat sinks and thereby representing a high capacity against earth.

**3.6 Installation instructions**

The switching of LEDs on secondary side is supported. The functioning of the LC in combination with dimming devices (e.g. PWM) cannot be guaranteed and has to be checked individually before using in combination.

**4. Electrical values**

**4.1.1 Efficiency vs. load 120 V, 60 Hz**

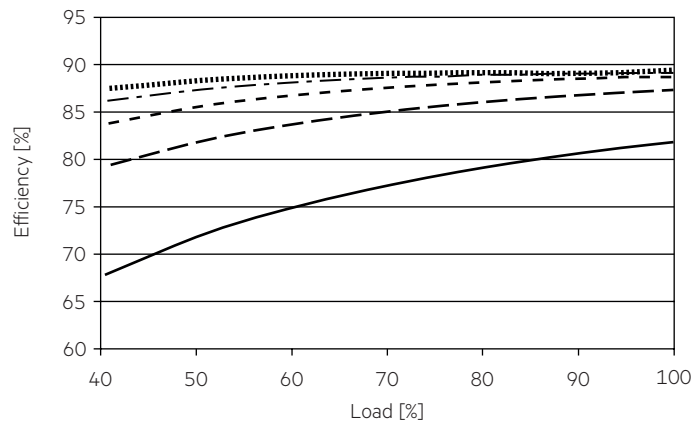

**4.1.2 Efficiency vs. load 230 V, 50 Hz**

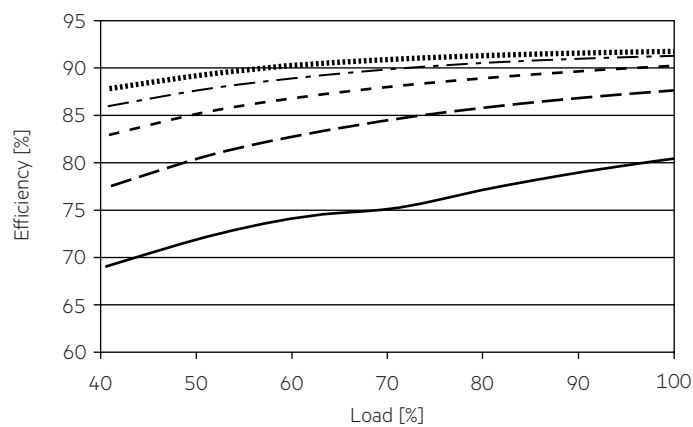

**4.1.3 Efficiency vs. load 277 V, 60 Hz**

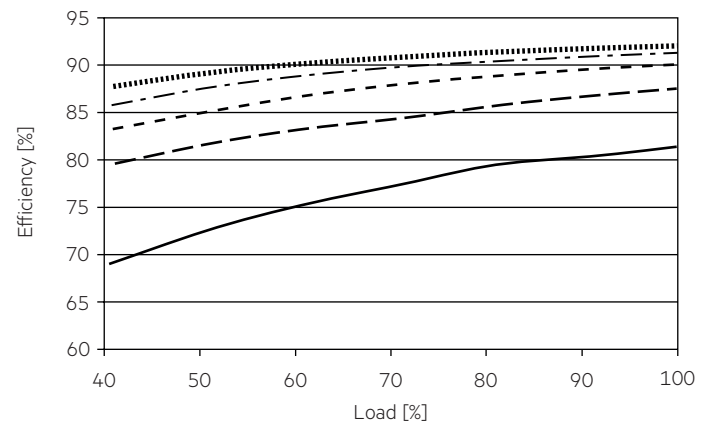

**4.2.1 Power factor vs. load 120 V, 60 Hz**

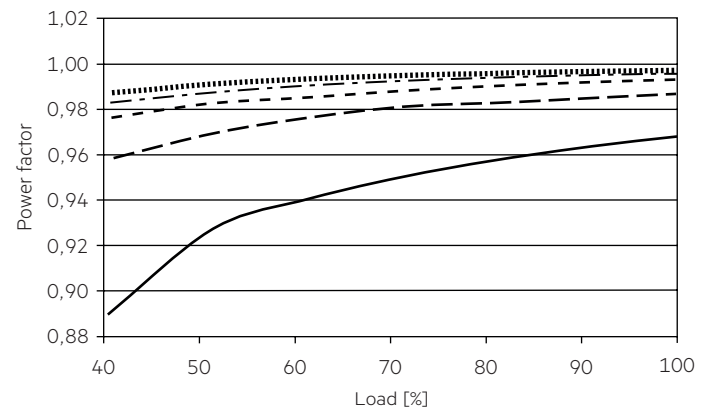

**4.2.2 Power factor vs. load 230 V, 50 Hz**

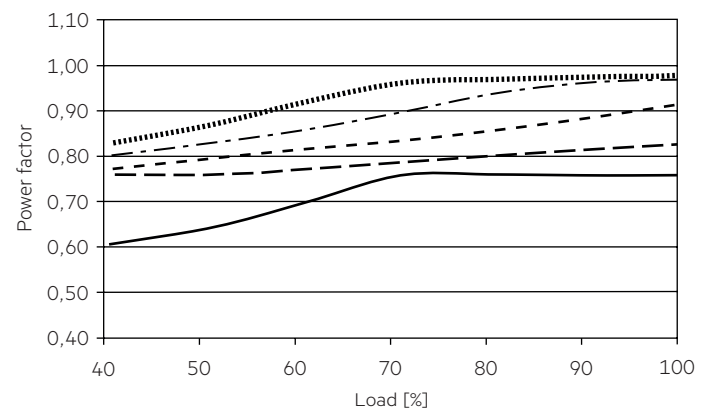

4.2.3 Power factor vs. load 277 V, 60 Hz

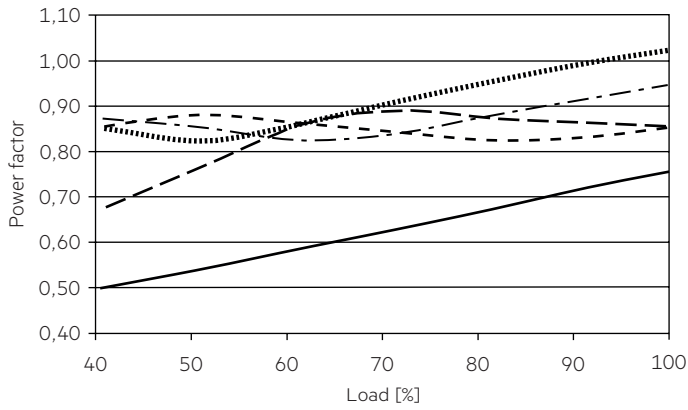

4.3.3 THD vs. load 277 V, 60 Hz

THD without harmonic < 5 mA or 0.6 % of the input current.

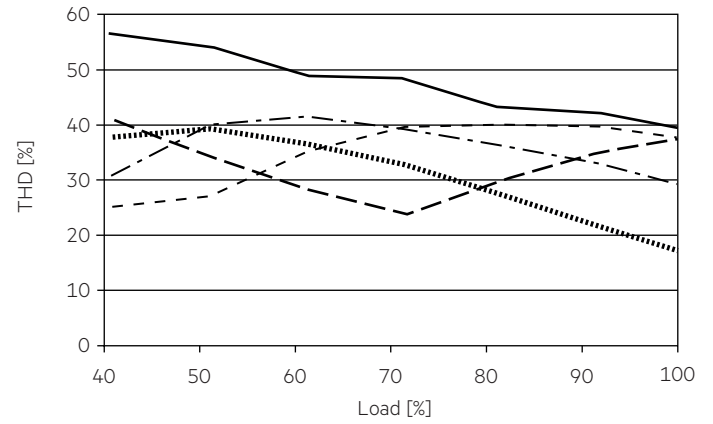

4.3.1 THD vs. load 120 V, 60 Hz

THD without harmonic < 5 mA or 0.6 % of the input current.

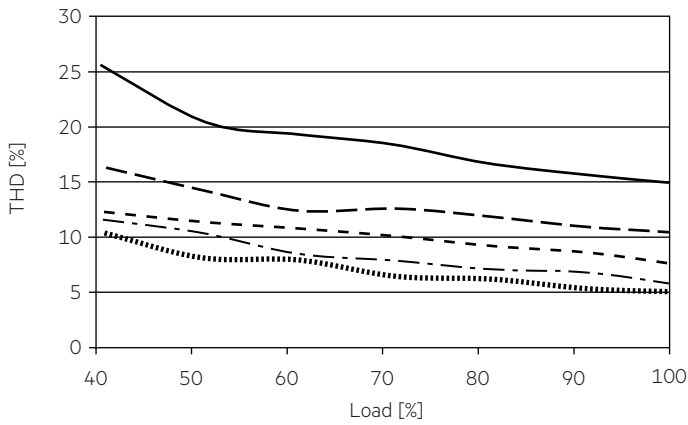

4.4.1 Input current vs. load 120 V, 60 Hz

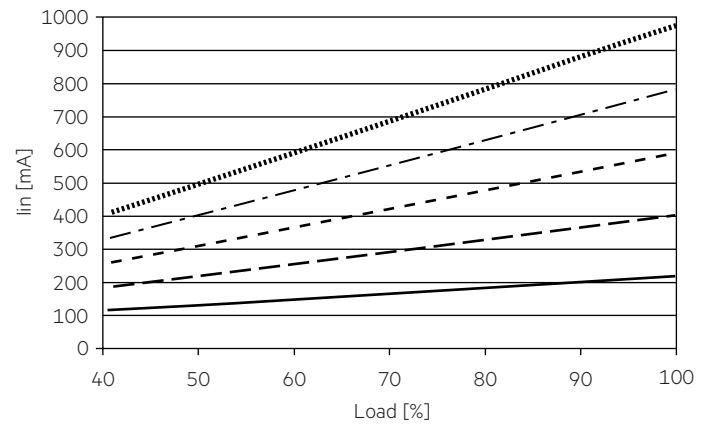

4.3.2 THD vs. load 230 V, 50 Hz

THD without harmonic < 5 mA or 0.6 % of the input current.

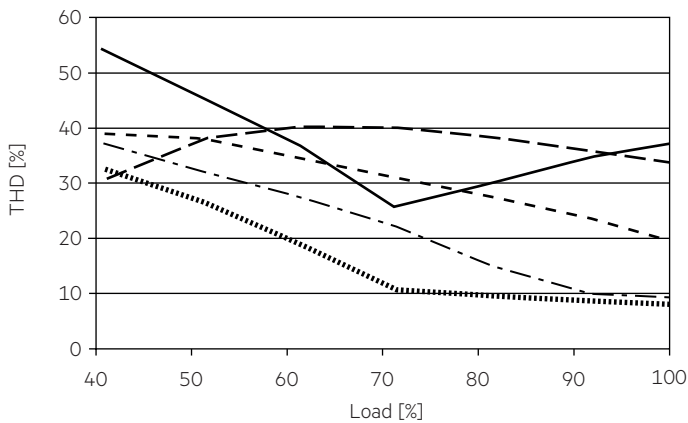

4.4.2 Input current vs. load 230 V, 50 Hz

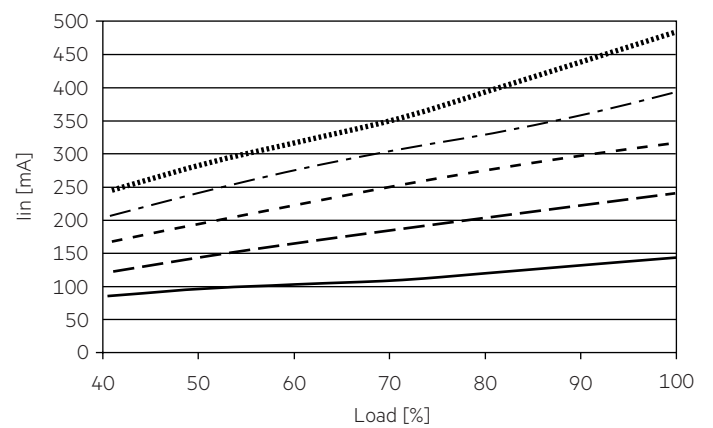

**4.4.3 Input current vs. load 277 V, 60 Hz**

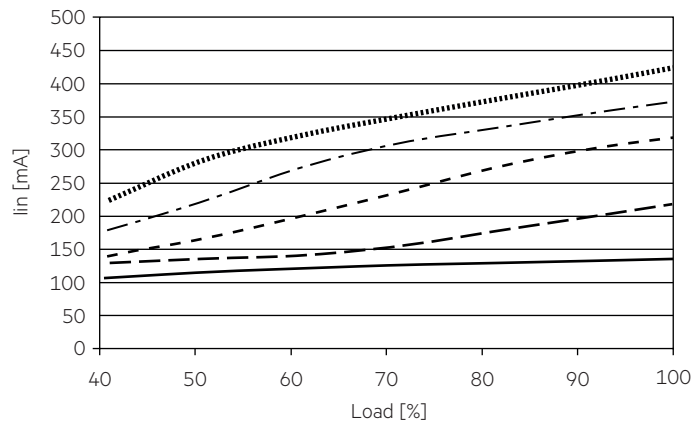

**4.5.3 Input power vs. load 277 V, 60 Hz**

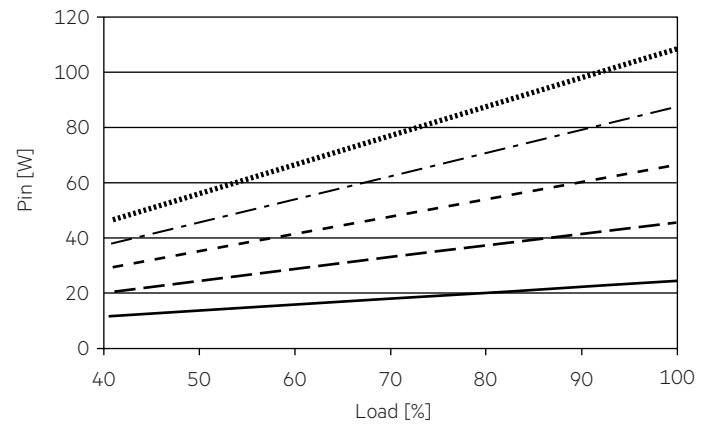

**4.5.1 Input power vs. load 120 V, 60 Hz**

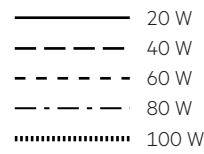
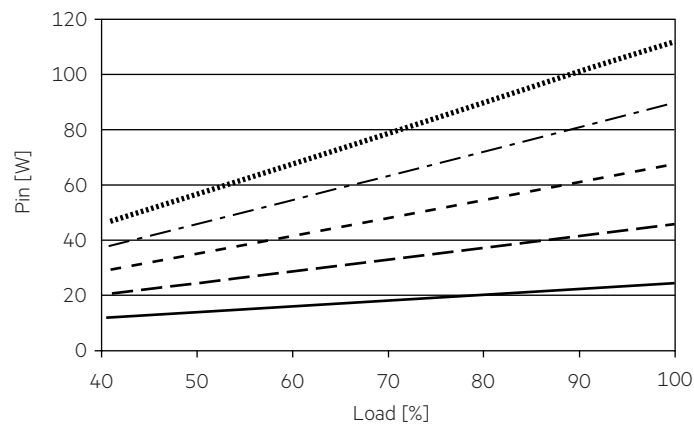

**4.5.2 Input power vs. load 230 V, 50 Hz**

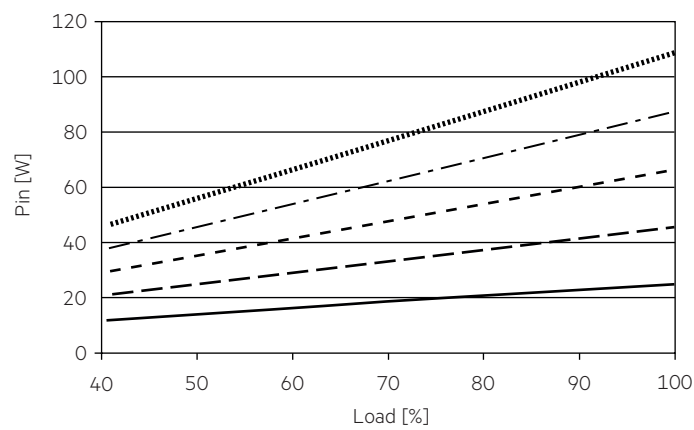

#### 4.6 Maximum loading of automatic circuit breakers

##### Maximum loading of automatic circuit breakers at 120 V, 60 Hz

Automatic circuit breaker type	C10	C13	C16	C20	B10	B13	B16	B20	Inrush current	
Installation Ø	1.5 mm <sup>2</sup>	1.5 mm <sup>2</sup>	1.5 mm <sup>2</sup>	2.5 mm <sup>2</sup>	1.5 mm <sup>2</sup>	1.5 mm <sup>2</sup>	1.5 mm <sup>2</sup>	2.5 mm <sup>2</sup>	I <sub>max</sub>	time
<b>LC 100W 24V IP67 L EXC UNV</b>	5	6	8	10	3	3	4	5	31A	656 µs

##### Maximum loading of automatic circuit breakers at 230 V, 50 Hz

Automatic circuit breaker type	C10	C13	C16	C20	B10	B13	B16	B20	Inrush current	
Installation Ø	1.5 mm <sup>2</sup>	1.5 mm <sup>2</sup>	1.5 mm <sup>2</sup>	2.5 mm <sup>2</sup>	1.5 mm <sup>2</sup>	1.5 mm <sup>2</sup>	1.5 mm <sup>2</sup>	2.5 mm <sup>2</sup>	I <sub>max</sub>	time
<b>LC 100W 24V IP67 L EXC UNV</b>	5	6	8	10	3	3	4	5	59 A	628 µs

##### Maximum loading of automatic circuit breakers at 277 V, 60 Hz

Automatic circuit breaker type	C10	C13	C16	C20	B10	B13	B16	B20	Inrush current	
Installation Ø	1.5 mm <sup>2</sup>	1.5 mm <sup>2</sup>	1.5 mm <sup>2</sup>	2.5 mm <sup>2</sup>	1.5 mm <sup>2</sup>	1.5 mm <sup>2</sup>	1.5 mm <sup>2</sup>	2.5 mm <sup>2</sup>	I <sub>max</sub>	time
<b>LC 100W 24V IP67 L EXC UNV</b>	5	6	8	10	3	3	4	5	72 A	632 µs

#### 4.7 Harmonic distortion in mains supply in %

120 V, 60 Hz:

Type	THD	3	5	7	9	11
<b>LC 100W 24V IP67 L EXC UNV</b>	< 15	< 12	< 10	< 7	< 5	< 3

230 V, 50 Hz:

Type	THD	3	5	7	9	11
<b>LC 100W 24V IP67 L EXC UNV</b>	< 15	< 12	< 10	< 7	< 5	< 3

277 V, 60 Hz:

Type	THD	3	5	7	9	11
<b>LC 100W 24V IP67 L EXC UNV</b>	< 15	< 12	< 10	< 7	< 5	< 3

Acc. to 6100-3-2. Harmonics < 5 mA or < 0.6 % (whatever is greater) of the input current are not considered for calculation of THD.

## 5. Functions

### 5.1 Short-circuit behaviour

In case of a short circuit on the secondary side (LED) the LED Driver switches off. After elimination of the short-circuit fault the LED Driver will recover automatically.

### 5.2 No-load operation

The LED Driver will not be damaged in the no-load operation. A voltage of 25.2V DC is permanent at the output.

### 5.3 Over load protection

If the output current is exceeded, the LED Driver enter hiccup modus. After elimination of the overload fault the LED Driver will recover automatically.

### 5.4 Over temperature protection

Over temperature protection will be activated for  $t_c > 90^\circ\text{C}$ . The Driver is shot down when over temperature protection triggered. Auto-recovery when fault condition removed.

## 6. Miscellaneous

### 6.1 Insulation and electric strength testing of luminaires

Electronic devices can be damaged by high voltage. This has to be considered during the routine testing of the luminaires in production.

According to UL 8750 (informative only!) each luminaire should be submitted to an insulation test with 500 V<sub>DC</sub>. The dielectric withstand test equipment shall employ a transformer of 500-VA or larger capacity and have a variable output voltage that is essentially sinusoidal or continuous direct current. The applied potential is to be increased from zero at a substantially uniform rate until the required test level is reached, and is to be held at that level for 1 minute.

As an alternative, UL8750 (informative only!) describes a test of the electrical strength with 2V AC + 1000V (or 1.414 x V DC). To avoid damage to the electronic devices this test must not be conducted.

### 6.2 Conditions of use and storage

Humidity: 10 % up to max. 95 %, not condensed (max. 56 days/year at 95 %)

Storage temperature: -40 °C up to max. +85 °C

The devices have to be within the specified temperature range (ta) before they can be operated.

### 6.3 Additional information

Additional technical information at [www.tridonic.com](http://www.tridonic.com) → Technical Data

Guarantee conditions at [www.tridonic.com](http://www.tridonic.com) → Services

Life-time declarations are informative and represent no warranty claim. No warranty if device was opened.