



Downlight Performer MW

- Geavanceerde, hoogwaardige LED-downlight
- Uniek optisch lensconcept met mat witte (MW) reflector en lage verblinding
- Minimale armatuur-hoogte (max 73mm)
- Directe vervanging voor CFL downlights
- IP44 (lichtuitvoerkant)
- Voorzien van beschermingsfolie ter voorkoming van stof en vuil in het armatuur gedurende de montage



Specificaties

Artikelcode	Artikelomschrijving	Equivalent (W)	Vermogen (W)	Lumen	Efficiëntie (lm/W)	UGR	CCT (K)	CRI	Gewicht (kg/st)
Statisch									
140057175	LEDDownlightRc-P-MW R200-33W-4000	CFL 2x32W	33	3630	110	≤22	4000	≥ 80	0,76

Accessoires



140060647
LEDDownlightRc-P-SI-E-Adapter-200-225



140061243
LEDDownlightRc-P-R200-Surface-Module-WH



549098001300
LEDDownlightRc-P EM-kit 1h



542098030700
Junction-Box-WH

140060648
LEDDownlightRc-P-SI-E-Adapter-200-250

549098001400
LEDDownlightRc-P EM-kit 3h

Artikel- en verpakkingsinformatie

Artikel			Doosverpakking			
Artikelcode	Artikelomschrijving	EU HS Code	Afmetingen (mm) (LxBxH)	Brutogewicht (kg)	EAN	st/doos
140057175	LEDDownlightRc-P-MW R200-33W-4000	94051190	260x260x118	1,18	6956712692795	1
140060647	LEDDownlightRc-P-SI-E-Adapter-200-225	94059900	250x250x0.8	0,23	6956321894139	1
140060648	LEDDownlightRc-P-SI-E-Adapter-200-250	94059900	275x275x0.8	0,20	6956321894146	1
140061243	LEDDownlightRc-P-R200-Surface-Module-WH	94059900	277x277x240	2,66	6956321841416	1
542098030700	Junction-Box-WH	85369010	43x103.4x26	0,06	6941408868684	1
549098001300	LEDDownlightRc-P EM-kit 1h	85044083	490x390x150	0,98	6941497709592	1
549098001400	LEDDownlightRc-P EM-kit 3h	85044083	490x390x150	1,08	6941497709585	1

Technische specificaties	
Levensduur (L70)	70.000 u
Levensduur (L80)	50.000 u
Aan-/Uit-cycli	100.000
Kleurconsistentie (SDCM)	3
Dimbaarheid	On-Off
Bundelhoek	70°
Afwerking	Wit RAL9003
IP voorzijde	IP44
IP-klasse achterzijde	IP20
Slagvastheid	IK02
Beschermingsklasse	II
Risicogroep (EN 62471)	RG0 / RG1 (23W, 33W & 44W)
Voorschakelapparaat inbegrepen	Ja
Gloeidraadtest	650°C
Vermogensfactor	≥ 0,9

Elektrische aansluiting	
Frequentie	50/60 Hz
Nom. spanning	220-240 V
DC ingangsspanning	Zie catalogusbijlage Aansluitwaarden
230V Kabellengte	0.3 m

Materiaal eigenschappen	
Materiaal behuizing	Gegoten Aluminium
Materiaal optiek	Polycarbonaat

Toepassingscondities	
Bedrijfstemperatuur	-10-+40°C
Gebruikstemperatuur	+25°C
Opslagtemperatuur	-25-+50°C

5 JAAR GARANTIE



ENERGY

OPPLE Lighting
140057175

33
kWh/1000h

2019/2015

Maatschets (mm)

LEDDownlight Driver

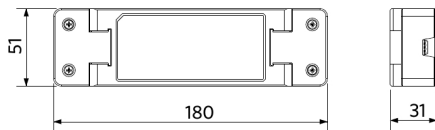

LEDDownlightRc-P-MW R200

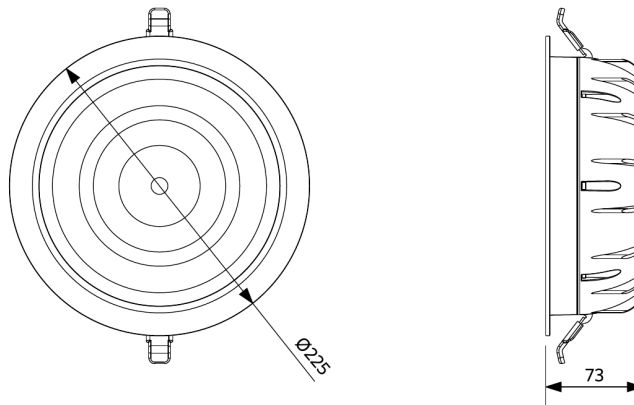

LEDDownlight Driver Tunable White

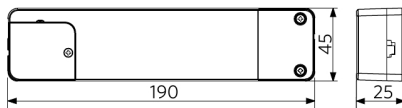

LEDDownlightRc-P-MW R200
LEDDownlightRc-P-R200-Surface-Module



Fotometrische gegevens

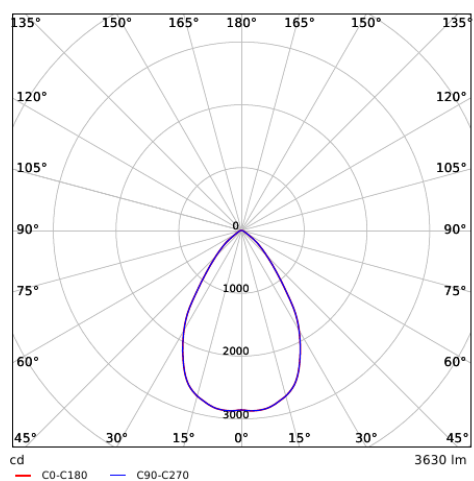

Tekening inbouwmaat (mm)

LEDDownlightRc-P-MW R200
Ø200

