

LED Bathroom mirror luminaire

LED Bathroom mirror luminaire, IP44, with opal diffuser for homogenous lighting and Vario Flex technology. Colour Rendition > 90 for best lighting quality. Total luminous flux: 800 lm. Luminaire input power: 9 W. Luminaire efficacy: 89 lm/W. Colour rendering Ra > 90, colour temperature 3000/3500/4000 K, adjustable via switch. Lifetime: 50.000hrs @L70. Chromaticity tolerance (initial MacAdam): 4. Impact strength: IK08. FLEX technology allows to adjust the input power on site by 2 steps (FLEX1: 800 lm (9W), FLEX2: 600 lm (7W)). For flex data on other colour temperatures please visit website. Dimensions: 450 x 59 x 81 mm, weight: 0.65 kg.

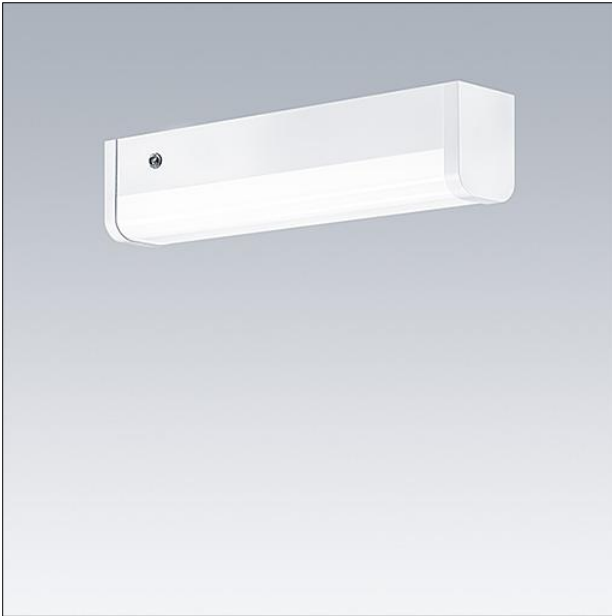

TE_ELSAVARIOFLEX_F_445_PERSP.jpg

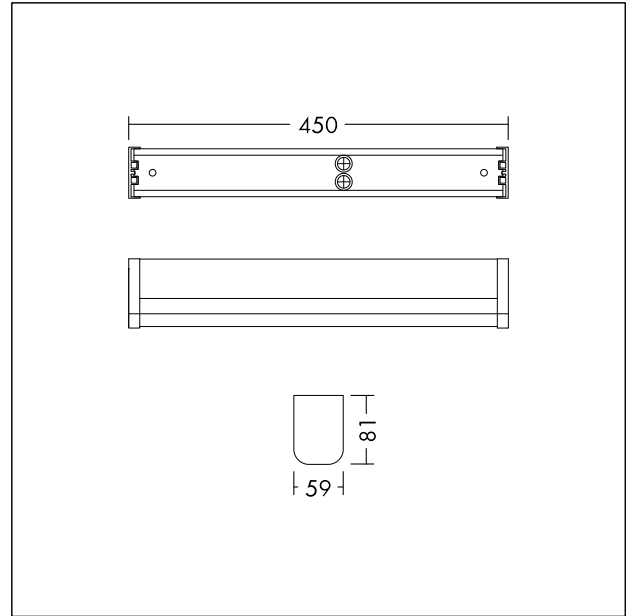

TE_ELSAVARIOFLEX_M_450.wmf

Light Distribution

STD - standard

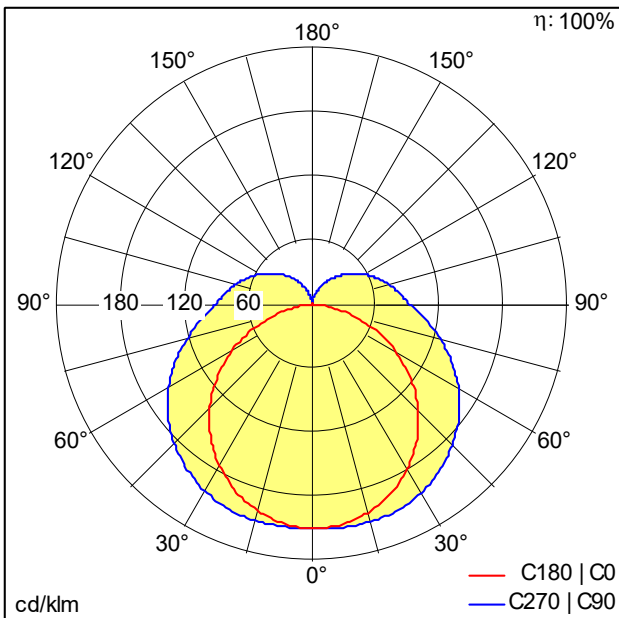

TE_ELSA_VARIOFLEX_450_800_940_FLEX1.idt

- Light Source: LED
- Luminaire luminous flux*: 800 lm
- Luminaire efficacy*: 89 lm/W
- Colour Rendering Index min.: 90
- Correlated colour temperature*: 3000-4000 Kelvin
- Chromaticity tolerance (initial MacAdam): 4
- Rated median useful life*: L70 50000 h at 25 °C
- Ballast: 1x LED_Con
- Luminaire input power*: 9 W Power factor = 0.9
- Dimming: Fixed output
- Maintenance category CIE 97: D - Enclosed IP2X
- Total harmonic distortion (THD): 20.00 %

This product contains a light source of energy efficiency class E.

All values marked with an * are rated values. Connected electrical load and luminous flux are subject to an initial tolerance of +/- 10%, the most similar colour temperature is subject to an initial tolerance of +/- 150K. Unless stated otherwise, the values apply to an ambient temperature of 25°C.