



**Driver LC 100W 24V SC SNC**  
essence series

**Product description**

- Constant voltage LED Driver
- Can be either used built-in or independent with clip-on strain-relief (see data sheet chapter: 1. Standards)
- Output voltage 24 V
- Max. output power 100 W
- Dimmable via PWM LED dimmers
- Nominal life-time up to 50,000 h
- 5-year guarantee

**Typical application**

- Cove lighting, facade accent lighting, ceiling integration

**Technical details**

- 24 V, 100 W
- Small design (295 x 43 x 30 mm) with stretched-compact strain relief
- Very good THD performance in wide load range < 5 %
- Output LF voltage ripple (< 120 Hz) ± 1.5 %
- Small cross section
- Push terminal for simple wiring

**System solution**

- Tridonic LLE-FLEX ADV G2 600, 1,200, 1,800 lm/m
- Tridonic LLE-FLEX EXC 600, 1,200, 1,800, 2,500 lm/m
- In connection with Flex accessories wire to PCB plug



**Standards**, page 3



System solution





### Driver LC 100W 24V SC SNC

essence series

#### Technical data

Rated supply voltage	220 – 240 V
AC voltage range	198 – 264 V
Mains frequency	50 / 60 Hz
Oversvoltage protection	320 V, 48 h
Typ. current (at 230 V, 50 Hz, full load) <sup>①</sup>	486 mA
Max. input power	113 W
Typ. efficiency (at 230 V / 50 Hz / full load)	92 %
$\lambda$ (at 230 V, 50 Hz, full load) <sup>①</sup>	0,98
Typ. input current in no-load operation	63 mA
Typ. input power in no-load operation	1,8 W
In-rush current (peak / duration)	40 A / 186 $\mu$ s
THD (at 230 V, 50 Hz, full load) <sup>①</sup>	< 4 %
Starting time (at 230 V, 50 Hz, full load) <sup>①</sup>	< 0,5 s
Turn off time (at 230 V, 50 Hz, full load)	< 0,5 s
Hold on time at power failure (output)	0 s
Output voltage tolerance	$\pm$ 1 V
Output LF voltage ripple (< 120 Hz)	$\pm$ 1,5 %
Max. output voltage (no-load voltage)	25 V
Burst capability	1 kV
Mains surge capability (between L – N)	1 kV
Mains surge capability (between L/N – PE)	2 kV
Life-time	up to 50,000 h
Dimensions L x W x H	295 x 43 x 29,8 mm

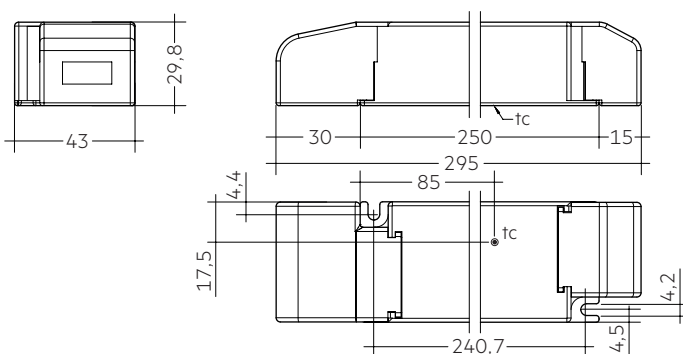

With strain-relief

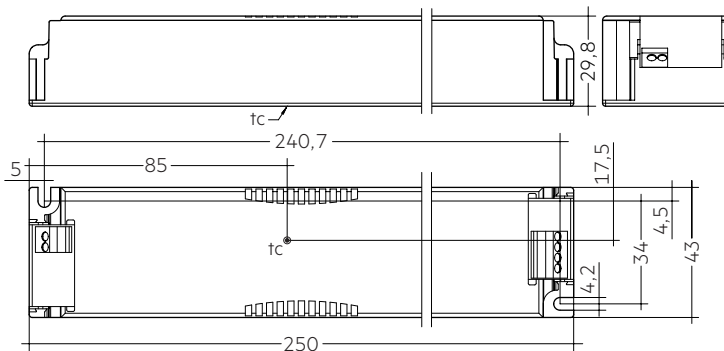

Without strain-relief

#### Ordering data

Type	Article number	Packaging carton <sup>②</sup>	Packaging, low volume	Packaging, high volume	Weight per pc.
<b>Multi packaging</b>					
<b>LC 100W 24V SC SNC</b>	<b>87500666</b>	10 pc(s).	80 pc(s).	800 pc(s).	0,227 kg
<b>Single packaging</b>					
<b>LC 100W 24V SC SNC SP</b>	<b>87500668</b>	10 pc(s).	80 pc(s).	800 pc(s).	0,227 kg

<sup>②</sup> The strain relief is included in both packaging variants.  
In the single packaging each Driver has also an individual packaging.

#### Specific technical data

Type	Load	Forward voltage	Output current	Max. output power (at 24 V, full load)	Typ. power consumption (at 24 V, full load)	Typ. current consumption (at 24 V, full load)	Max. casing temperature tc	Ambient temperature ta max.
<b>LC 100W 24V SC SNC</b>	30 %	24 V	1,250 mA	30 W	33,6 W	166 mA	75 °C	-20 ... +50 °C
	40 %	24 V	1,667 mA	40 W	44,0 W	207 mA	80 °C	-20 ... +50 °C
	50 %	24 V	2,083 mA	50 W	54,5 W	250 mA	80 °C	-20 ... +50 °C
	60 %	24 V	2,500 mA	60 W	65,2 W	295 mA	85 °C	-20 ... +50 °C
	70 %	24 V	2,917 mA	70 W	75,9 W	340 mA	85 °C	-20 ... +50 °C
	80 %	24 V	3,333 mA	80 W	86,7 W	385 mA	90 °C	-20 ... +50 °C
	90 %	24 V	3,750 mA	90 W	97,6 W	432 mA	90 °C	-20 ... +50 °C
	100 %	24 V	4,167 mA	100 W	108,5 W	478 mA	90 °C	-20 ... +45 °C

<sup>①</sup> Valid at 100 % dimming level.

## 1. Standards

EN 55015  
EN 61000-3-2  
EN 61000-3-3  
EN 61347-1  
EN 61347-2-13  
EN 62384  
EN 61547

For devices with strain-reliefs the following test marks apply:

 ... Class II luminaires

 ... Independent device

For devices without strain-reliefs the following test mark apply:

 ... Double or reinforced insulation

## 2. Thermal details and life-time

### 2.1 Expected life-time

Expected lifetime					
Type	Output load	ta	40 °C	45 °C	50 °C
LC 100W 24V SC SNC	> 90 ... ≤ 100 W	tc	85 °C	90 °C	–
		Life-time	100,000 h	70,000 h	–
	≥ 80 ... ≤ 90 W	tc	80 °C	85 °C	90 °C
		Life-time	>100,000 h	>100,000 h	70,000 h
	≥ 50 ... < 80 W	tc	75 °C	80 °C	85 °C
		Life-time	>100,000 h	>100,000 h	100,000 h
< 50 W	tc	70 °C	75 °C	80 °C	
	Life-time	>100,000 h	>100,000 h	>100,000 h	

The LED control gear is designed for a life-time stated above under reference conditions and with a failure probability of less than 10 %.

The relation of tc to ta temperature depends also on the luminaire design.

If the measured tc temperature is approx. 5 K below tc max., ta temperature should be checked and eventually critical components (e.g. ELCAP) measured. Detailed information on request.

## 3. Installation / wiring

### 3.1 Circuit diagram

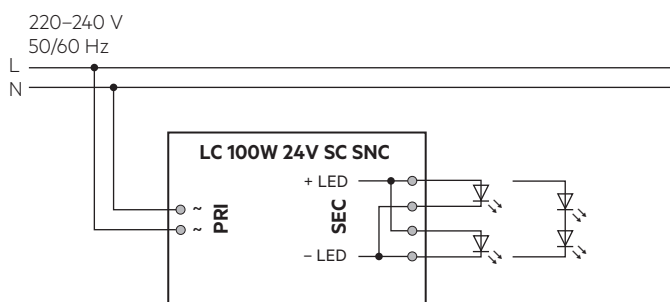

### 3.2 Mains supply wiring

The wiring can be in stranded wires with ferrules or solid from 0.5 – 1.5 mm<sup>2</sup>. For perfect function of the push-wire terminals (WAGO 250) the strip length should be 7.2 – 8.8 mm.

wire preparation:  
0.5 – 1.5 mm<sup>2</sup>

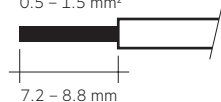

### 1.1 Glow wire test

according to EN 61347-1 with increased temperature of 850 °C passed.

Primary strain relief for cables with bigger cable sheath

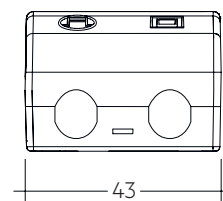

Permissible cable jacket diameter: 2.2 – 9 mm

Secondary strain relief for cable with smaller cable sheath

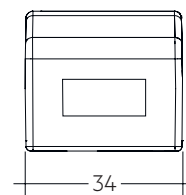

Permissible cable jacket diameter: 3 – 9 mm

### 3.3 Loose wiring

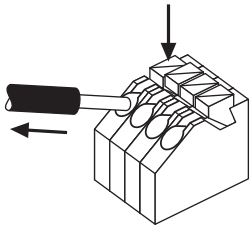

#### Release of the wiring

Press down the "push button" and remove the cable from front.

### 3.4 Fixing conditions when using as independent Driver with Clip-On

Dry, acidfree, oilfree, fatfree. It is not allowed to exceed the maximum ambient temperature ( $t_a$ ) stated on the device. Minimum distances stated below are recommendations and depend on the actual luminaire. Is not suitable for fixing in corner.

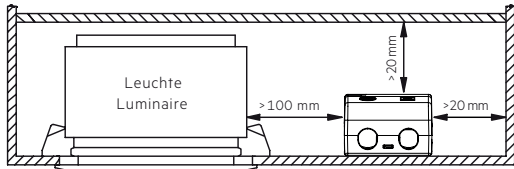

### 3.5 Wiring guidelines

- The cables should be run separately from the mains connections and mains cables to ensure good EMC conditions.
- The LED wiring should be kept as short as possible to ensure good EMC. The max. secondary cable length is 2 m (4 m circuit).
- The secondary wires (LED module) should be routed in parallel to ensure good EMC performance.
- The LED Driver has no inverse-polarity protection on the secondary side. Wrong polarity can damage LED modules with no inverse-polarity protection.
- Wrong wiring of the LED Driver can lead to malfunction or irreparable damage.
- To avoid the damage of the Driver, the wiring must be protected against short circuits to earth (sharp edged metal parts, metal cable clips, louver, etc.).

### 3.6 Installation instructions

The LED module and all contact points within the wiring must be sufficiently insulated against 3 kV surge voltage. Air and creepage distance must be maintained.

## 4. Electrical values

### 4.1 Efficiency vs. load

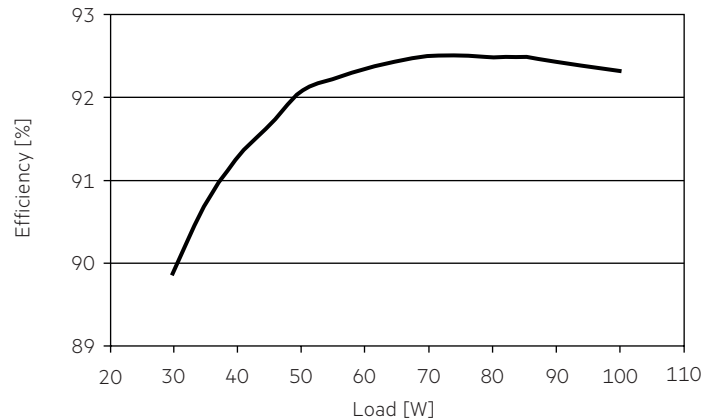

### 4.2 Power factor vs. Load

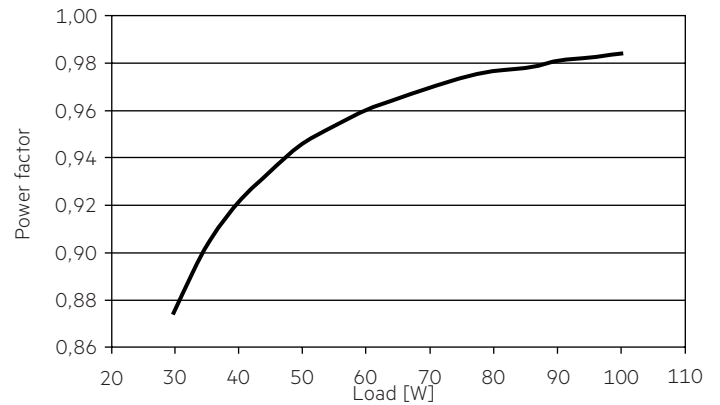

### 4.3 Input power vs. Load

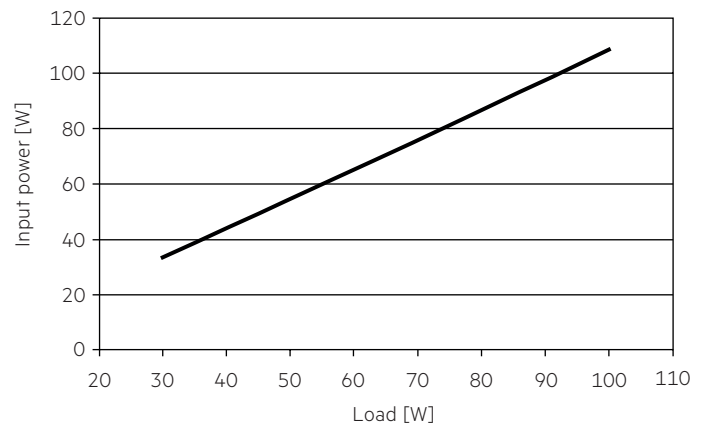

#### 4.4 Input current vs. Load

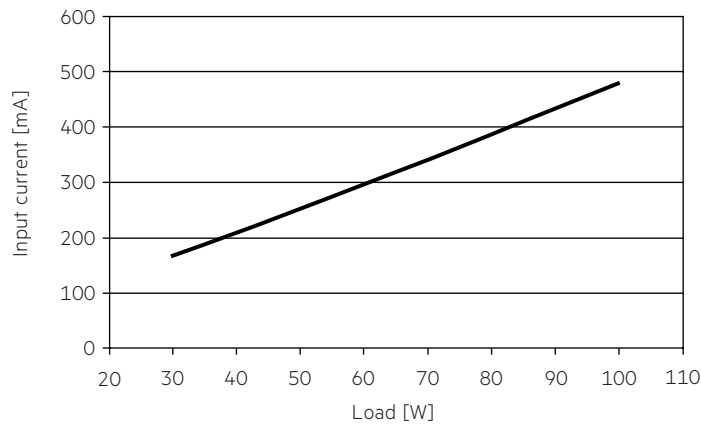

#### 4.5 THD vs. Load

THD without harmonic < 5 mA (0.6 %) of the input current:

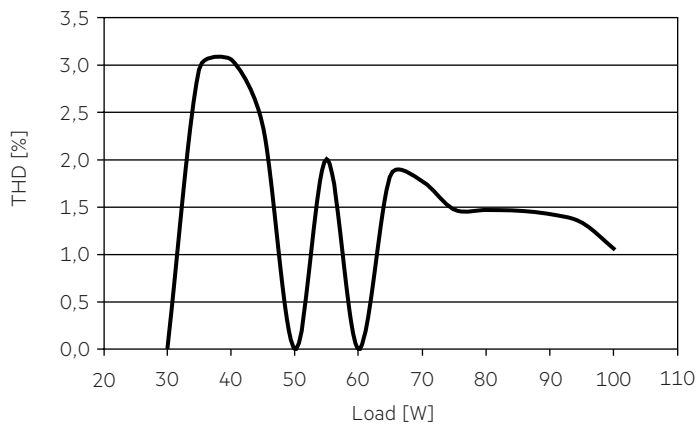

#### 4.6 Maximum loading of automatic circuit breakers in relation to inrush current

Automatic circuit breaker type	C10	C13	C16	C20	B10	B13	B16	B20	Inrush current	
Installation Ø	1.5 mm <sup>2</sup>	1.5 mm <sup>2</sup>	1.5 mm <sup>2</sup>	2.5 mm <sup>2</sup>	1.5 mm <sup>2</sup>	1.5 mm <sup>2</sup>	1.5 mm <sup>2</sup>	2.5 mm <sup>2</sup>	I <sub>max</sub>	time
<b>LC 100W 24V SC SNC</b>	22	30	38	48	13	18	23	29	40 A	186 µs

This are max. values calculated out of inrush current! Please consider not to exceed the maximum rated continuous current of the circuit breaker. Calculation uses typical values from ABB series S200 as a reference. Actual values may differ due to used circuit breaker types and installation environment.

#### 4.7 Harmonic distortion in the mains supply (at 230 V / 50 Hz and full load) in %

	THD	3.	5.	7.	9.	11.
<b>LC 100W 24V SC SNC</b>	< 4	< 2	< 2	< 2	< 2	< 2

Acc. to 6100-3-2. Harmonics < 5 mA or < 0.6 % (whatever is greater) of the input current are not considered for calculation of THD.

## 5. Functions

### 5.1 Overload protection

If the output current range is exceeded, the LED will flicker, and output voltage will be reduced.  
When fault is removed, the driver can go back to work automatically without resetting input main power.

### 5.2 Overtemperature protection

The LED Driver is protected against temporary thermal overheating. If the temperature limit is exceeded the LED will flicker, and restart automatically after the driver cold down. The temperature protection is activated approx. + 15 °C above T<sub>c</sub> max.

### 5.3 Short-circuit behaviour

In case of a short circuit at the LED output the LED output is switched off. When fault is removed, the driver can go back to work automatically without resetting input main power.

### 5.4 No-load operation

The LED Driver will not be damaged in the no-load operation. When the output is floating and doesn't connect the LED modules, the output voltage will keep the max. voltage (< 25 V). After connecting the LED load, the driver works normally without resetting the main power.

### 5.5 Hot plug-in

Hot plug-in is supported.  
If a LED load is connected, the device does not need to be restarted before the output will be activated again.

## 7. Miscellaneous

### 7.1 Insulation and electric strength testing of luminaires

Electronic devices can be damaged by high voltage. This has to be considered during the routine testing of the luminaires in production.

According to IEC 60598-1 Annex Q (informative only!) or ENEC 303-Annex A, each luminaire should be submitted to an insulation test with 500 V<sub>DC</sub> for 1 second. This test voltage should be connected between the interconnected phase and neutral terminals and the earth terminal.  
The insulation resistance must be at least 2 MΩ.

As an alternative, IEC 60598-1 Annex Q describes a test of the electrical strength with 1500 V<sub>AC</sub> (or 1.414 x 1500 V<sub>DC</sub>). To avoid damage to the electronic devices this test must not be conducted.

### 7.2 Conditions of use and storage

Humidity: 5 % up to max. 85 %,  
not condensed  
(max. 56 days/year at 85 %)

Storage temperature: -40 °C up to max. +80 °C

The devices have to be acclimatised to the specified temperature range (t<sub>a</sub>) before they can be operated.

### 7.3 Additional information

Additional technical information at  
[www.tridonic.com](http://www.tridonic.com) → Technical Data

Guarantee conditions at  
[www.tridonic.com](http://www.tridonic.com) → Services

Life-time declarations are informative and represent no warranty claim.  
No warranty if device was opened.