

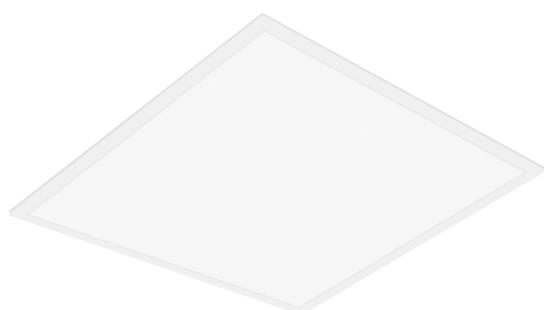

# PRODUCT DATASHEET

## PL COMP 600 V 33W 840

PANEL COMPACT 600 | Square recessed panel luminaires, for 600 x 600 mm ceiling systems



### Areas of application

- Direct replacement for luminaires with fluorescent lamps
- Offices, conference rooms
- Reception areas, foyers, corridors, elevators
- Suitable for recessed ceiling systems with grid size of 600 x 600 mm

### Product benefits

- Low flicker light thanks to special electronic control gear
- Energy savings thanks to system efficacy of up to 110 lm/W
- External driver with an optional 3-pole through-wiring feature
- Versions with DALI ECG available
- 5 years guarantee

### Product features

- Extruded aluminum frame
- Polystyrene diffuser
- Lifetime (L80/B10): up to 50,000 h (at 25 °C)



## TECHNICAL DATA

### Electrical data

Nominal wattage	33.00 W
Nominal voltage	220...240 V
Mains frequency	50...60 Hz
Nominal current	150.000 mA
Inrush current	12.3 A
Inrush current time $T_{h50}$	52 $\mu$ s
Max. number of luminaires per miniature circuit breaker B16	61
Max. number of luminaires per miniature circuit breaker C10	48
Max. number of luminaires per miniature circuit breaker C16	78
Power factor $\lambda$	> 0.90
Total harmonic distortion	< 10 %
Protection class	II
Operating mode	External LED driver

### Photometrical data

Luminous flux	3630 lm
Luminous efficacy	110 lm/W
Color temperature	4000 K
Light color (designation)	Cool White
Color rendering index Ra	> 80
Standard deviation of color matching	$\leq$ 5 sdc <sub>m</sub>
Low flicker	Yes
Flickering metric (Pst LM)	<1
Stroboscope effect metric (SVM)	< 0.4
Photobiological safety group acc. to EN62778	RG0
Beam angle	120 °

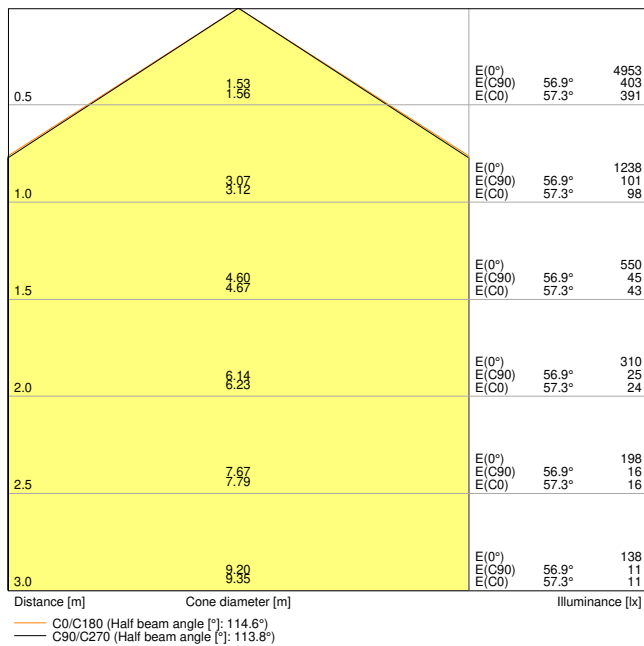

PL COMP 600 V 33W 840 EM CONVERSION BOX

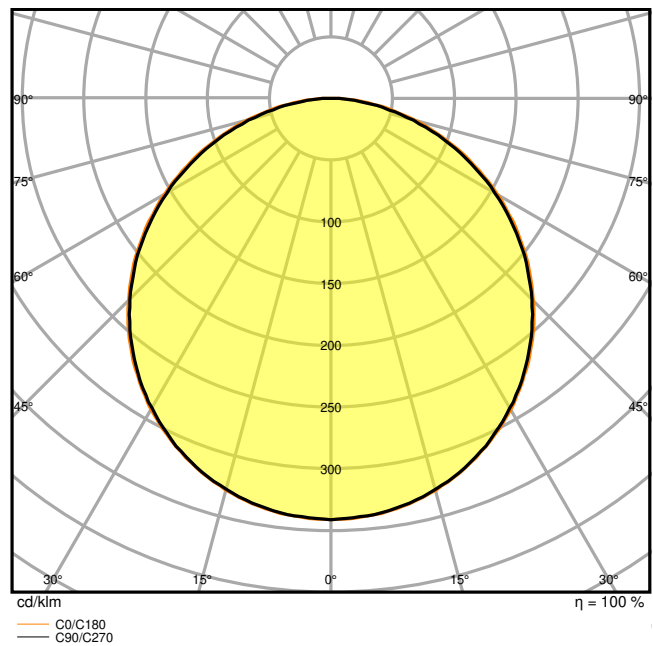

PL COMP 600 V 33W 840 EM CONVERSION BOX

Dimensions & Weight

Length	595.00 mm
Width	595.00 mm
Height	32.00 mm
Product weight	1543.00 g

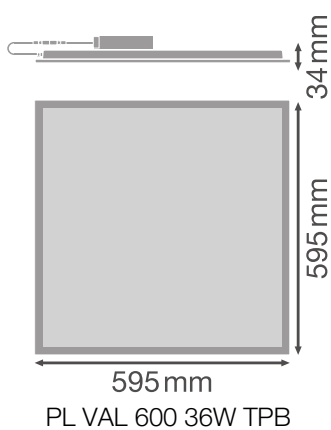

Materials & Colors

Product color	White
Housing color	White
Body material	Aluminum
Cover material	Polystyrene (PS)
Light emitting surface material	Polystyrene
Glow Wire Test according to IEC 60695-2-12	650 °C
Mercury content	0.0 mg

### Application & Mounting

Ambient temperature range	-10...+45 °C
Temperature range at storage	-20...+70 °C
Type of connection	Screwless terminal, 2-Pole (L, N)
Type of protection	IP40/IP20
Protection class IK (shock resistance)	IK02
Dimmable	No
Mounting type	Recessed/Suspended/Surface
Mounting location	Ceiling
Application environment	Indoor
Mounting length	575 mm
Mounting width	575 mm
Mounting depth	50,0 mm
Adjustable	No
With light source	Yes

### Lifespan

Lifespan L70/B50 at 25 °C	70000 h <sup>1)</sup>
Lifespan L80/B10 at 25 °C	50000 h <sup>1)</sup>
Lifespan L80/B50 at 25 °C	50000 h
Lifespan L90/B10 at 25 °C	40000 h
Number of switching cycles	50000

<sup>1)</sup> t<sub>h</sub>: L70 / B50 @ 25 °C (T<sub>a</sub>), t<sub>h</sub>: L80 / B10 @ 25 °C (T<sub>a</sub>), t<sub>h</sub>: L90 / B10 @ 25 °C (T<sub>a</sub>)

### Control gear







Output current	700 mA
ECG - Output ripple current	< 7 %
ECG - Length	116.7 mm



ECG - Width	49.9 mm
ECG - Height	27 mm
Recommended control gear	LEDV DR DALI-P-44/220-240/1050

Certificates & Standards

Standards	CE / CB / TÜV / UKCA / EAC / EPD
Luminaire with limited surface temperature, "D sign"	No
Ball shot safe	No
EPD	LEDV-00008-V01.01-EN
Replaceable light source (EPREL)	Not replaceable

Accessories Optional

Product image	Product name	EAN
	DR DALI - P -44/220-240/1050	4058075779723
	DR AY ZB+DALI CLAMP DUO	4058075483125
	EM CONVERSION BOX	4058075237025
	PANEL 600 SURFACE MOUNT KIT H75	4058075472914
	PANEL 600 SURFACE MOUNT KIT H70 VAL	4058075402843
	PANEL RECESSED MOUNT CLIPS VAL 4x	4058075409859

Product image	Product name	EAN
	PANEL 600 RECESSED MOUNT FRAME	4058075402881
	PANEL Suspension Kit	4058075402928
	CONNECTOR BOX 5POLE L/N 4x	4058075473010





### EQUIPMENT / ACCESSORIES











- Accessories for several mounting options available
- Security rope for luminaire included
- Security brackets preinstalled
- External control gear included
- Suitable for use with separate Emergency Conversion Box

### Safety advice

- All electrical connections must be made by a qualified person.
- Caution, risk of electric shock.
- The luminaires are not suitable for covering with thermally insulated material.

### DOWNLOAD DATA

Documents and certificates	Document name
 User instruction / safety instructions	UI PANEL COMPACT 2CCT
 Legal information	LISO Insert PL COMP 600 V
 Legal information	EM Insert PL COMP
 Legal information	Informationstext 18 Abs 4 ElektroG
 Declarations of conformity	CE Declaration of Conformity PL COMP V

Documents and certificates		Document name
	Declarations of conformity UKCA	UKCA Declaration of Conformity PL COMP V
Photometric and lighting design files		Document name
	IES file (IES)	PL COMP 600 V 33W 840 EM CONVERSION BOX
	LDT file (Eulumdat)	PL COMP 600 V 33W 840 EM CONVERSION BOX
	ULD file (DIALux)	PL COMP 600 V 33W 840
	ROLF file (RELUX)	PL COMP 600 V 33W 840
	UGR file (UGR table)	PL COMP 600 V 33W 840 EM CONVERSION BOX
	Light distribution curve type cone	PL COMP 600 V 33W 840 EM CONVERSION BOX
	Light distribution curve type polar	PL COMP 600 V 33W 840 EM CONVERSION BOX
CAD/BIM files		Document name
	BIM Revit 3D	Panel Compact
	CAD STEP 3D	PL COMP 600
Tender texts		Document name
	Tender documents	PANEL COMPACT 600 33W 840-EN

### LOGISTICAL DATA

Product code	Packaging unit (Pieces/Unit)	Dimensions (length x width x height)	Gross weight	Volume
4099854017902	Folding box 1	602 mm x 37 mm x 662 mm	1973.00 g	14.75 dm <sup>3</sup>
4099854017919	Shipping box 4	677 mm x 164 mm x 628 mm	8802.00 g	69.73 dm <sup>3</sup>

The mentioned product code describes the smallest quantity unit which can be ordered. One shipping unit can contain one or more single products. When placing an order, for the quantity please enter single or multiples of a shipping unit.

### ADDITIONAL CATALOG INFORMATION

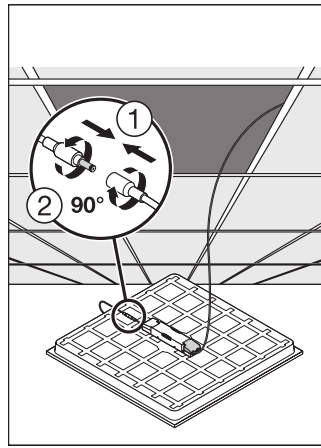
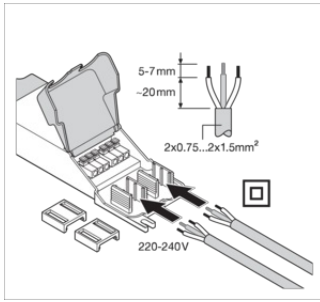

---

### References / Links

– For Guarantee see [www.ledvance.com/guarantee](http://www.ledvance.com/guarantee)

---

### DISCLAIMER

Subject to change without notice. Errors and omission excepted. Always make sure to use the most recent release.