

Product Data Sheet

GWR5251BW

ROAD [5] Range



High-power LED streetlight with cover, frame, and pole attachment in EN AB 46100 die-cast aluminium with low copper content, with polyester powder coating. Suitable for installation both on top of the pole and offset, with 5° pitch adjustment. Opening and closing system with integrated front handle. Closure fabricated in tempered flat glass (thickness 4 mm). Cable input via PG13.5. Safety switch. Cable plate in PA6.6+PV. Printed Circuit Board (PCB) in metal core. Metallic PC optic system. Common mode surge protection up to 10 kV. Operational up to 50°C ambient temperature but with reduction of the supply current as indicated in the Instruction Manual.

GENERAL INFORMATION		OPTIC AND ILLUMINATING FEATURES	
Context	Street and parking lighting	Optic	WIDE
Luminaire	LED Road Equipment	Unified Glare Rating	G*4 - ULOR = 0
Application	External	Lumen output (lm)	4200
Unique digital code (Datamatrix)	Currently not present	Efficacy (lm/W)	114
Colour	Graphite grey	Colour temperature	4000 K
Type of light source	LED	Colour Rendering Index	CRI>70
System power	37 W @ 0,5A	Standard Deviation Colour Matching	SDCM = 5
LED Lifetime	L90B10(Tq25°C)=150.000h; L80B10 (Tq25°C)>150.000h	Photobiological Risk Class	RG0
Weight (kg)	6.4	Standard	EN 60598-2-3, EN 60598-1 IEC/TR 62778
Warranty	5 years	ELECTRICAL AND LIGHTING FEATURES	
Stocking temperature	-	Supply voltage	220 - 240 V
Operating temperature	-25 +40 °C	Rated frequency (Hz)	50 / 60
MATERIALS		Driver failure rate	F10 = 100.000h Tq25°C
Body	Die-cast aluminium	Driver	Included
Shield type	4mm thick flat tempered glass	Overvoltage protection	DM 10KV / CM 10KV
Optic	Silver PVD aluminium reflector	Control System	Bi-power with self-learning
Gasket	Anti-aging silicone	INSTALLATION AND MAINTENANCE	
Locking Hook	Integrated front handle	Mounting and installation	Pole Head - Outreach
External screw	Stainless steel	Tilt	-20° + +10° side bracket - -10° + +20° pole head
Colour	Powder coating	Wiring	Isolating switch
STANDARDS AND APPROVALS		Fixing	Pole Head - Outreach
Classification	-	Light source replaceability	By professional
Device with reduced surface temperature	-	Controlgear replaceability	By professional
DIN 18032-3 certification	-	Driver Box	Built-in
IPEA	-	Maximum surface exposed to the wind	0.15 m²
Insulation class	II		
IP degree	IP66		
Mechanical resistance	IK08		
Glow Wire Test	-		

DIMENSIONAL

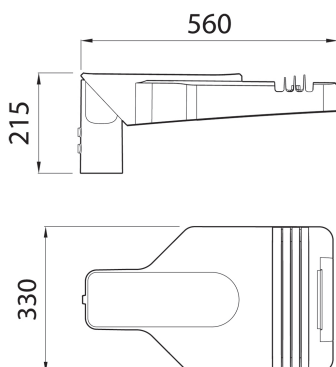

PHOTOMETRIC DISTRIBUTION

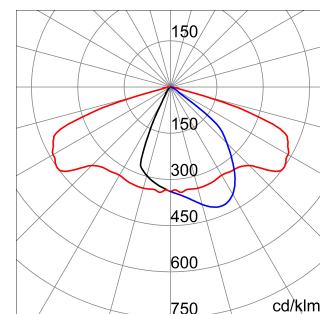

TECHNICAL SYMBOLOGY



IP
IP66

IK
IK08

GWT
-

Product Data Sheet

GWR5251BW

ROAD [5] Range

STANDARDS/APPROVALS

