

Product Data Sheet

GW16843

CHORUSMART - Domestic range



Supports for fixing modular devices of the ChoruSmart residential series, made of technopolymer with rib-enhanced structure that guarantees high performance. The range includes versions for mounting plates with rectangular boxes with capacity for up to 12 modules, versions matching international standard plates on round/square boxes and versions for DIN rail. They are suitable for flush-mount or wall-mount boxes and are equipped with screw or fixing clutch systems. The convenient front coupling/disconnect system of ChoruSmart modular devices also allows you to house modular devices with 1/2, 1, 2 and 3 modules.

Description	3 modules	Glow wire test	650 °C
Thermo-pressure with ball	70 °C	Standard	EN 60669-1
No. DIN modules	4	Electrocod	0122

DIMENSIONAL

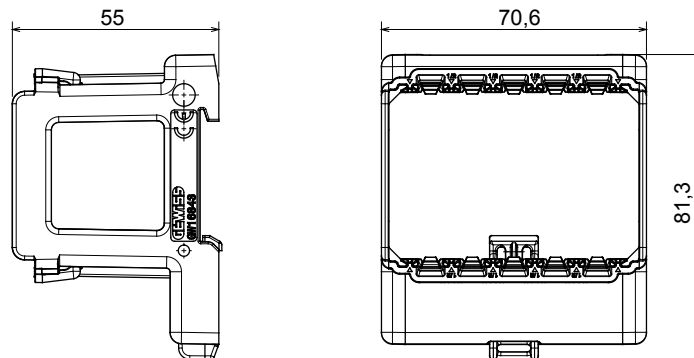

TECHNICAL SYMBOLOGY

GWT



650 °C

70 °C

STANDARDS/APPROVALS

